

—  — **ARGOFILE** —

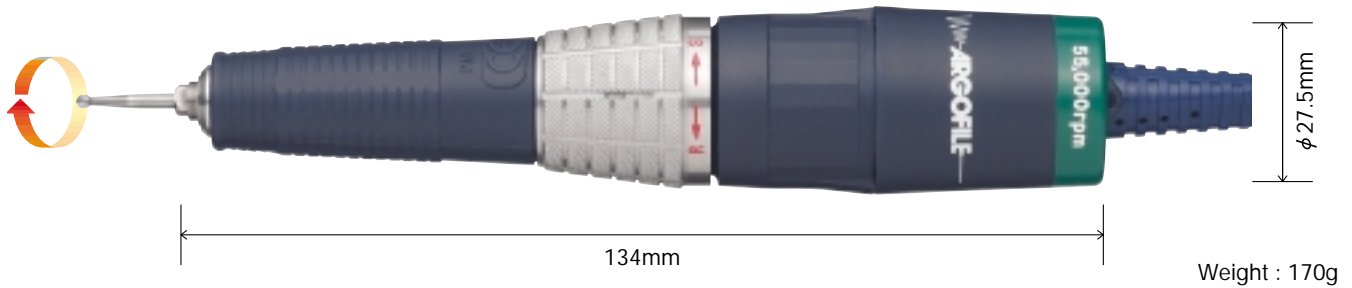

ARGOFILE A.F. SERIES

LA051 55,000rpm / High Speed



Biggest seller, most popular one-piece handpiece. Its lightweight well balanced construction and the world top r.p.m. of 55,000 make it ideal for precise deburring with C.B.N. or diamond bur.

Rated input voltage	Max shaft output	Max torque	Standard collet size	Special collet size
0-30V. DC.	58.6W	3.1N.cm.	2.35mm, 3mm	3.175mm

LA121 20,000rpm / High Torque

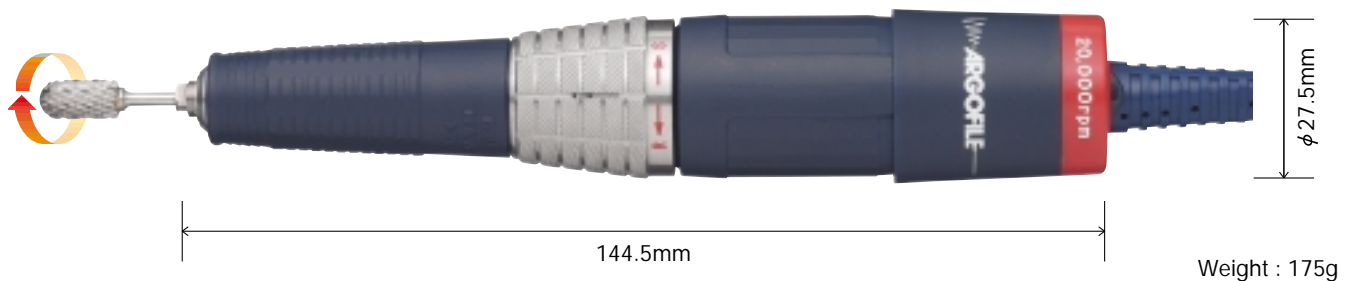

High torque yet slim line one-piece construction suitable for continuous production.

Rated input voltage	Max shaft output	Max torque	Standard collet size	Special collet size
0-30V. DC.	40.4W	6.5N.cm.	2.35mm, 3mm	3.175mm

LA131 35,000rpm / All-Arounder

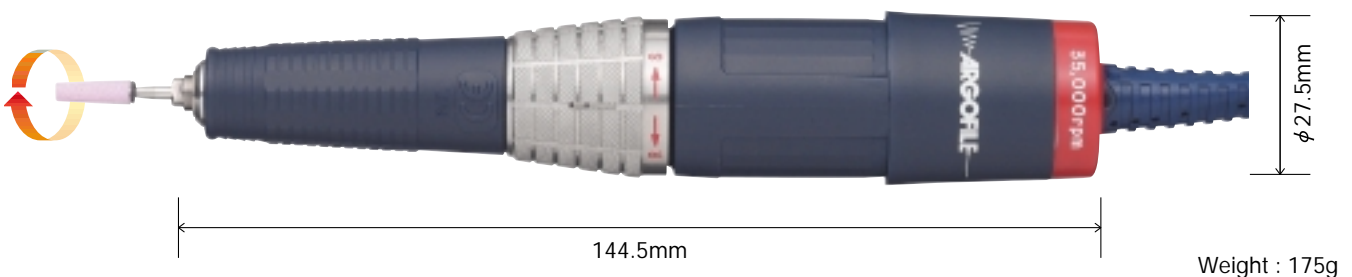

Slim, lightweight one-piece construction with 35,000 r.p.m.max.with medium torque make this handpiece a good all-rounder for most polishing applications.

Rated input voltage	Max shaft output	Max torque	Standard collet size	Special collet size
0-30V. DC.	55.7W	5.4N.cm.	2.35mm, 3mm	3.175mm

LA231 30,000rpm / All-Arounder



LA231 with its two-piece construction is a very adaptable handpiece and suitable for high-speed cutting and deburring with carbide and mounted points. The handpiece LA231 consists of head JA15 and motor LA23. The detachable motor LA23 can be used with interchangeable heads as illustrated on page 5.

Rated input voltage	Max shaft output	Max torque	Standard collet size	Special collet size
0-30V. DC.	65.7W	6.5N.cm.	2.35mm, 3mm	3.175mm



LA211 15,000rpm / High Torque

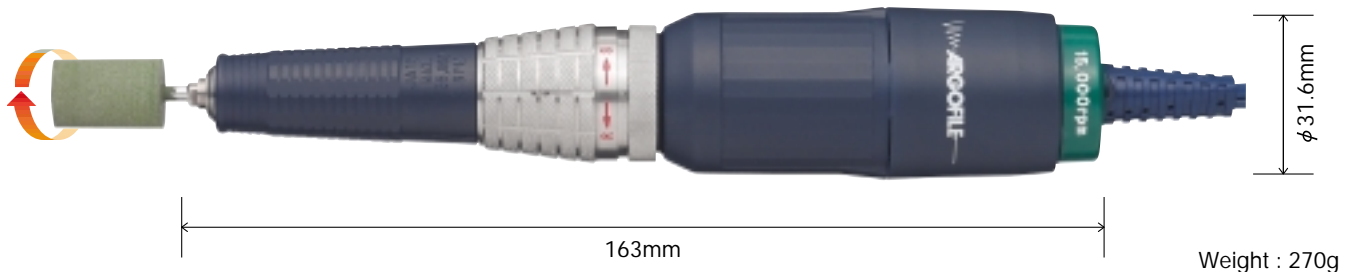

LA211 is a two-piece construction designed for especially tough applications such as grinding, heavy deburring, cutting and heavy duty polishing. The handpiece LA211 consists of head JA15 and motor LA21. The detachable motor LA21 can be used with interchangeable heads as illustrated on page 5.

Rated input voltage	Max shaft output	Max torque	Standard collet size	Special collet size
0-30V. DC.	49W	8.8N.cm.	2.35mm, 3mm	3.175mm



LA201 8,000rpm / Super Torque



LA201 two-piece construction handpiece with super torque is designed for the toughest jobs, use it for hard grinding, heavy deburring, cutting and polishing on all types of surfaces. The handpiece LA201 consists of head JA15 and motor LA20. The detachable motor LA20 can be used with interchangeable heads as illustrated on page 5.

Rated input voltage	Max shaft output	Max torque	Standard collet size	Special collet size
0-30V. DC.	22.8W	8.8N.cm.	2.35mm, 3mm	3.175mm



Reciprofile



RE35/RE55

RE55/35 reciprocating profilers are lightweight and comfortable handpieces for continuous polishing. Both models have adjustable stroke and floating head with 360° orientation.

Model	Rated input voltage	Available tool size	Reciprocating Stroke	Frequency
RE35	0-30V. DC.	φ 2.0-6.35mm	0-6mm	420~4,200Strokes/min
RE55	0-30V. DC.	φ 2.0-6.35mm	0-2mm	700~7,000Strokes/min

Swingfile

LA208 8,000rpm / Swingfile

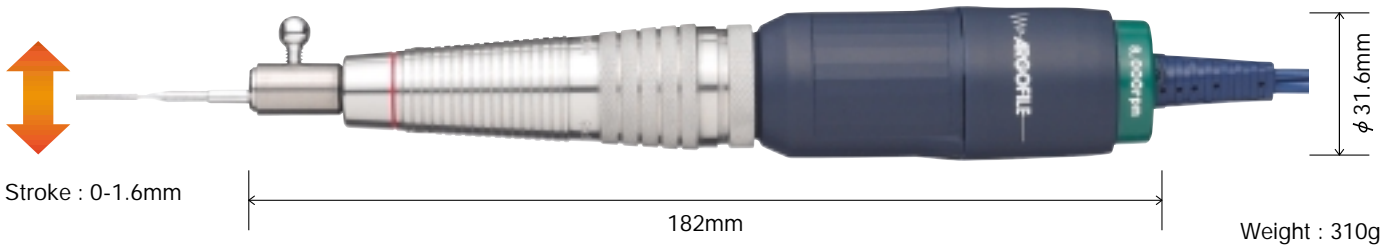

Swingfile LA208 a unique sideways reciprocating action with a choice of speed and stroke is perfect for polishing base areas in deep cavities, corners and deep slots. The handpiece LA208 consists of head JP11 and motor LA20. The detachable motor LA20 can be used with interchangeable heads as illustrated on page 5.

Rated input voltage	Max shaft output	Max torque	Available tool size
0-30V. DC.	22.8W	8.8N.cm.	φ 2.0-4.7mm

Tools for RE35/55 and LA208

FREE HOLDER

Cat. No. R1110

ABRASIVE PADS (self-adhesive backing)

Cat. No. R2001

FELT TIPS (self-adhesive backing)

Cat. No. R2001

HOLDERS

Holder (Short Type)

Cat. No. R1130

Holder (Long Type)

Cat. No. R1120

ELECTRO-DEPOSITED DIAMOND FILES

Cat. No. R3110, R3120, R3130

(Note : All measurements in millimeters)

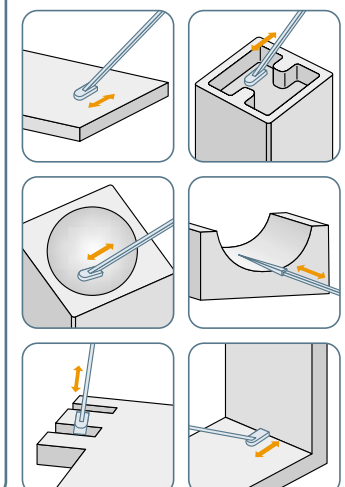

Angle Rotary

LA217 120° angle / 15,000rpm

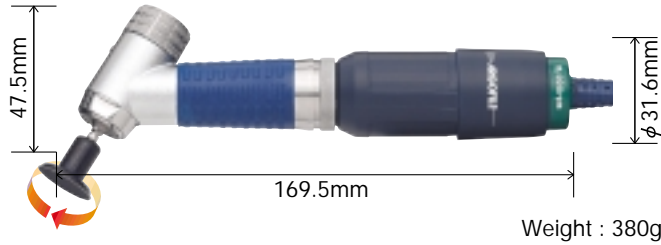

LA216 90° angle / 15,000rpm

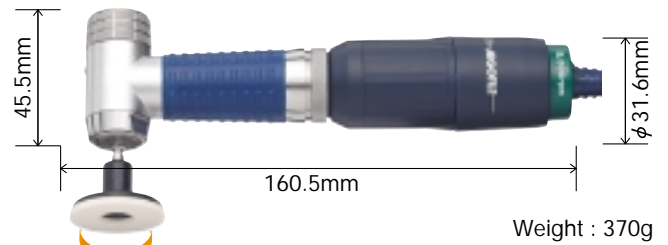

Suitable for polishing of round and flat surface. The handpiece LA216 (LA217) consists of head JR21 (JS21) and motor LA21. The detachable motor LA21 can be used with interchangeable heads as illustrated on page 5.

Model	Rated input voltage	Max shaft output	Max torque	Standard collet size	Special collet size
LA217	0-30V. DC.	49W	8.8N.cm.	2.35mm, 3mm	3.175mm
LA216	0-30V. DC.	49W	8.8N.cm.	2.35mm, 3mm	3.175mm

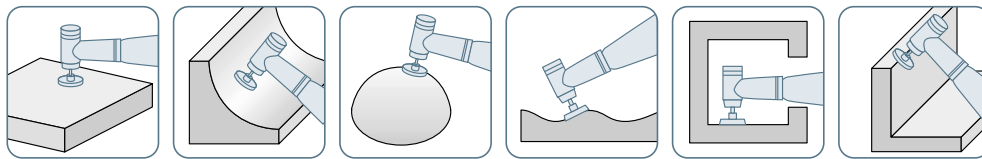

Tooling for Angle Rotary

SOFT RUBBER MANDRILS

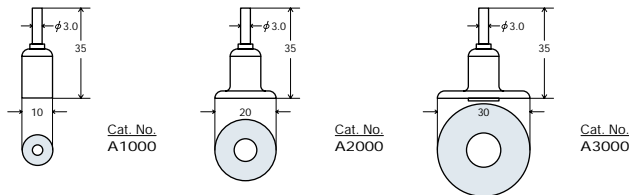

SILICON CARBIDE ABRASIVE DISCS

(self-adhesive backing)

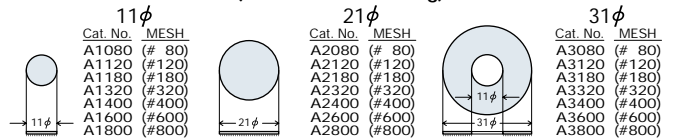

POLYMOND DIAMOND ABRASIVE DISCS

(self-adhesive backing)

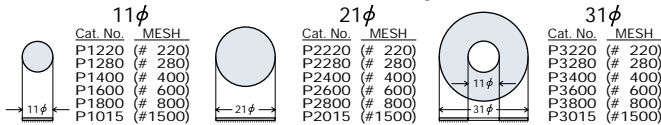

FELT DISCS

(self-adhesive backing)



(Note : All measurements in millimeters)

Belt Sander



BS33 Belt Sander

Suitable for deburring, removing EDM and machine tool marks, and sanding flat and curved surface and narrow slots.

Rated input voltage	Thin Belt Arm (BS1-100-1)	Standard Belt Arm (BS1-100-2) BS33 comes with this Belt Arm	Angle Arm (BS1-100-3)
0-30V. DC.			
Belt Speed 5-12m/sec	Belt Width : 4-6mm	Belt Width : 6-8mm	Belt Width : 6-8mm

ABRASIVE BELTS

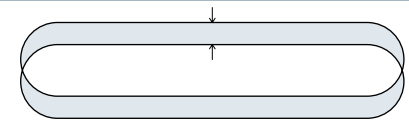

4mm width	6mm width	8mm width
Cat. No. MESH B4080 (# 80) B4120 (#120) B4180 (#180) B4320 (#320)	Cat. No. MESH B6080 (# 80) B6120 (#120) B6180 (#180) B6320 (#320)	Cat. No. MESH B8080 (# 80) B8120 (#120) B8180 (#180) B8320 (#320)

(Note : All measurements in millimeters)

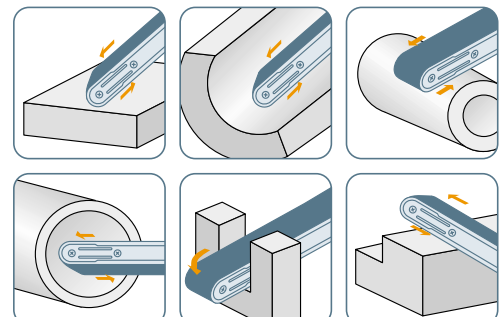

Standard Head JA15



Weight : 100g
Standard collet size 2.35, 3.0mm
Special collet size 3.175mm
Available with **LA23** **LA21** **LA20**

Swing Head JP11

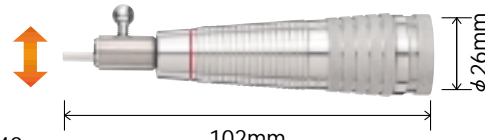

Weight : 140g
Available tool shank ϕ 2.0-4.7mm
Available with **LA20**

Heavy Duty Head JA33



Weight : 150g
Standard collet size 6.0mm
Special collet size 2.35, 3.0, 3.175, 6.35mm
Available with **LA23** **LA21** **LA20**

Slim Line 90° Angle Head SA90



Weight : 80g
Standard collet size 3.0mm
Special collet size 2.35, 3.175mm
Available with **LA21** **LA20**

Slender Head JA45

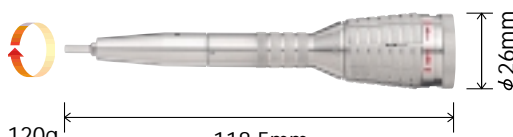

Weight : 120g
Standard collet size 3.0mm
Special collet size 2.35, 3.175mm
Available with **LA23** **LA21** **LA20**

Slim Line 90° Extension Angle Head SAE90

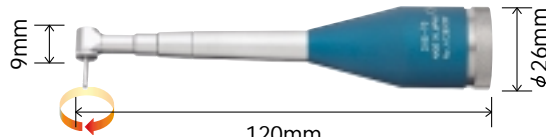

Weight : 90g
Standard collet size 1.6mm
Available with **LA21** **LA20**

90° Angle Head JR21

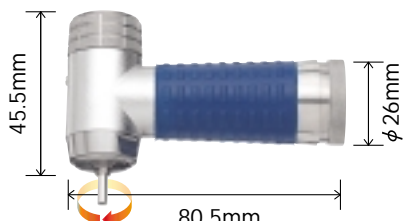

Weight : 200g
Standard collet size 2.35, 3.0mm
Special collet size 3.175mm
Available with **LA21** **LA20**

Slim Line 120° Angle Head SA120

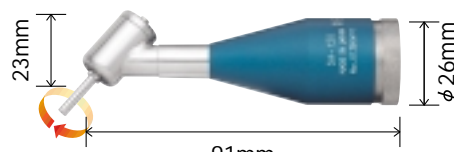

Weight : 80g
Standard collet size 3.0mm
Special collet size 2.35, 3.175mm
Available with **LA21** **LA20**

120° Angle Head JS21



Weight : 210g
Standard collet size 2.35, 3.0mm
Special collet size 3.175mm
Available with **LA21** **LA20**

1/4 Reduction Gear UT15



Weight : 150g
(Connect between the motor and head for four times torque and reduce speed one fourth.)
Available with **LA23** **LA21** **LA20**

LA23 30,000rpm



Weight : 170g

Rated input voltage	Max shaft output	Max torque
0-30V. DC.	65.7W	6.5N.cm.

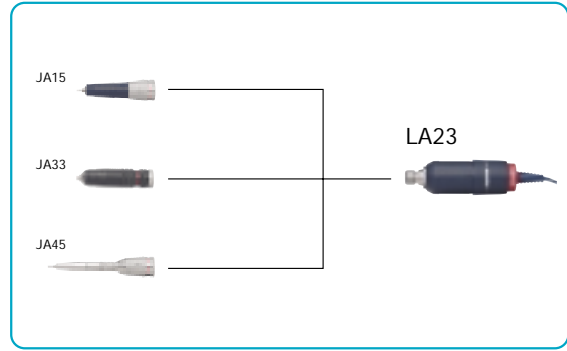

LA21 15,000rpm



Weight : 170g

Rated input voltage	Max shaft output	Max torque
0-30V. DC.	49W	8.8N.cm.

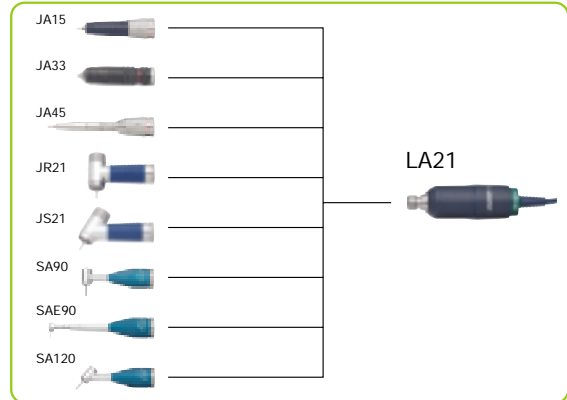

LA20 8,000rpm



Weight : 170g

Rated input voltage	Max shaft output	Max torque
0-30V. DC.	22.8W	8.8N.cm.

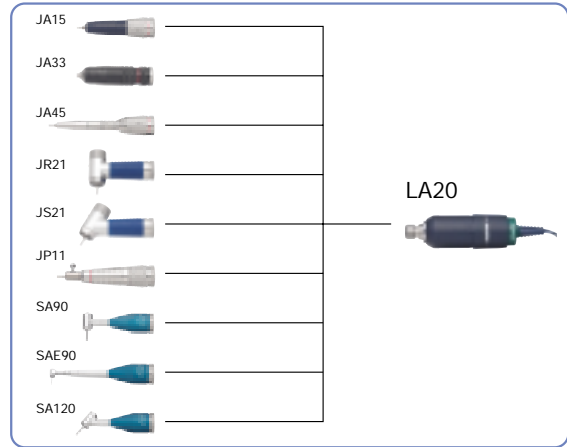

Collet Chucks & Reducing Sleeves

Collet Chucks

fit in : JA15/JA45/JR21/JS21

fit in : JA33

fit in : SA90/SA120

fit in : SAE90

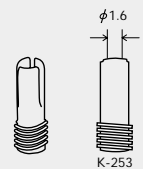
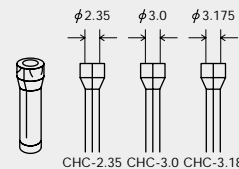
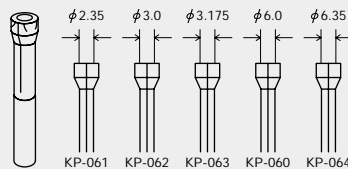
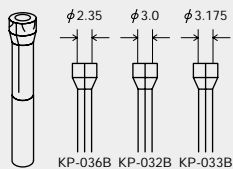

Reducing Sleeves

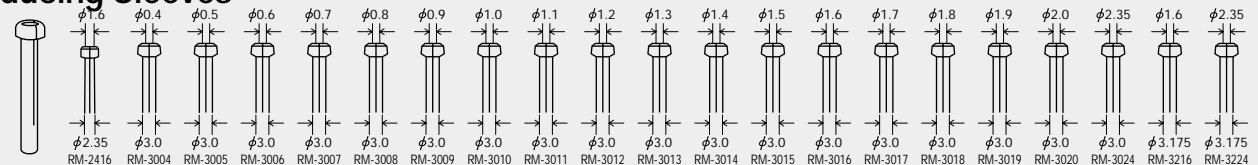

(Note : All measurements in millimeters)

Dual Controller

PA111/PA113

PA111(120V)
PA113(230V)

Dual power pack type PA11 with two output stations and individual speed controller enables 2 operators function. Heavy duty circuitry and overload function provides superior torque to AF series handpieces when applied to PA11. Available in 120V or 230V AC, 50/60Hz. Output voltage : 30V DC.

Foot Controls suitable for PA11

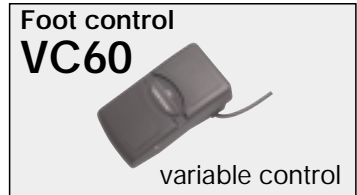

Single Station Controller

PS220

Compact type controller with beep sound, cut-out switching for overload. Variable control either by hand or with foot control. PS220 has its unique voltage selector switch that allows operation at either 110V or 220V. Available in 50/60Hz. Output voltage : 30V DC.

Foot Controls suitable for TPF-77



Optional Accessories

Extention Cord **EC30**



Length 1.5m

Handpiece Cradle **TRC-02**

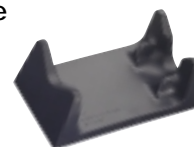

ARGOFILE JAPAN LIMITED

3-4, Kanda-Mitoshiro-Cho,
Chiyoda-ku, Tokyo101-0053, Japan
TEL : 81-(0)3-3233-1133
FAX : 81-(0)3-3233-1129
E-mail : info@argofile.co.jp
website : www.argofile.co.jp