



IFS MCR300-1T/1S User Manual

Copyright	© 2012 UTC Fire & Security Company. All rights reserved.
Trademarks and patents	Interlogix, IFS MCR300-1T/1S, the IFS Brand and logo are trademarks of UTC Fire & Security. Other trade names used in this document may be trademarks or registered trademarks of the manufacturers or vendors of the respective products.
Manufacturer	UTC Fire & Security Americas Corporation, Inc. 2955 Red Hill Avenue, Costa Mesa, CA 92626-5923, USA
Version	This document applies to IFS MCR300-1T/1S version 1.0.
Certification	  N4131
FCC compliance	Class A: This equipment has been tested and found to comply with the limits for a Class A digital device, pursuant to part 15 of the FCC Rules. These limits are designed to provide reasonable protection against harmful interference when the equipment is operated in a commercial environment. This equipment generates, uses, and can radiate radio frequency energy and, if not installed and used in accordance with the instruction manual, may cause harmful interference to radio communications. Operation of this equipment in a residential area is likely to cause harmful interference in which case the user will be required to correct the interference at his own expense.
ACMA compliance	Notice! This is a Class A product. In a domestic environment this product may cause radio interference in which case the user may be required to take adequate measures.
European Union directives	2004/108/EC (EMC directive): Hereby, UTC Fire & Security declares that this device is in compliance with the essential requirements and other relevant provisions of Directive 2004/108/EC



2002/96/EC (WEEE directive): Products marked with this symbol cannot be disposed of as unsorted municipal waste in the European Union. For proper recycling, return this product to your local supplier upon the purchase of equivalent new equipment, or dispose of it at designated collection points. For more information see: www.recyclethis.info.

**Contact
information**

www.utcfireandsecurity.com or
www.interlogix.com

Customer support

www.interlogix.com/customer-support

Contents

Overview 1

Package Contents 1

Product Features 2

Hardware Overview 3

Front Panel 4

Back Panel 4

Power Notice: 4

Link Fault Pass through (LFP) 5

Link Loss Carry Forward (LLCF) 5

Link Loss Return (LLR) 6

Installing the MCR300-1T/1S 8

Duplex Mode Support 9

LED indicators 9

System 9

10/100/1000Base-TX Port 9

1000Base-SX/LX SFP Slot 9

Cable Connection 10

Specifications 11

RJ45 Pin Assignments 12

Fiber Optical Cable Connection Parameter 13

Contacting Technical Support 14

Overview

Thank you for purchasing the IFS MCR300-1T/1S 10/100/1000Mbps Ethernet Twisted pair to 1000Base-SX/LX SFP Gigabit Media Converter. This MCR300-1T/1S is used to convert one type of media signal to another equivalent type that allows two different segments to connect easily, efficiently and inexpensively.

This MCR300-1T/1S can be used as a standalone unit or as a slide-in module in the MCR-R15 19" media chassis (up to 15 modules) for a combined multi-mode and single-mode fiber network at a central wiring closet.

Package Contents

Check the contents of your package for the following parts:

- MCR300-1T/1S x1
- User's Manual x1

If any of these items are missing or damaged, please contact your dealer immediately. If possible, retain the product box including the original packing material to return it to for repair/replacement.

Note: The MCR300-1T/1S comes with one vacant SFP module slot. The mini GBIC SFP module is not included in the package.

Product Features

The MCR300-1T/1S provides the following key features:

- Complies with the IEEE 802.3 10Base-T, IEEE 802.3u 100Base-TX, IEEE 802.3ab 1000Base-T, IEEE 802.3z 1000Base-SX/LX Ethernet standard
- Bridge mode Media Converter with TP port supports 10/100/1000Base-T and auto-MDI/MDIX
- Auto-Negotiation for 10/100/1000Base-T; Half-duplex or Full-duplex for 10Mbps and 100Mbps, full-duplex for 1000Mbps
- LED indicators for simple diagnostics and management
- Provides DIP switch for LFP function (Disable/Enable) setting
- Compact in size, easy installation
- OAM (TS-1000 and IEEE 802.3ah) supported
- 9K Jumbo frame supported
- Can be installed in the IFS MCR-R15 19" Media Converter Chassis

Hardware Overview

Figure 1: All Panel Views

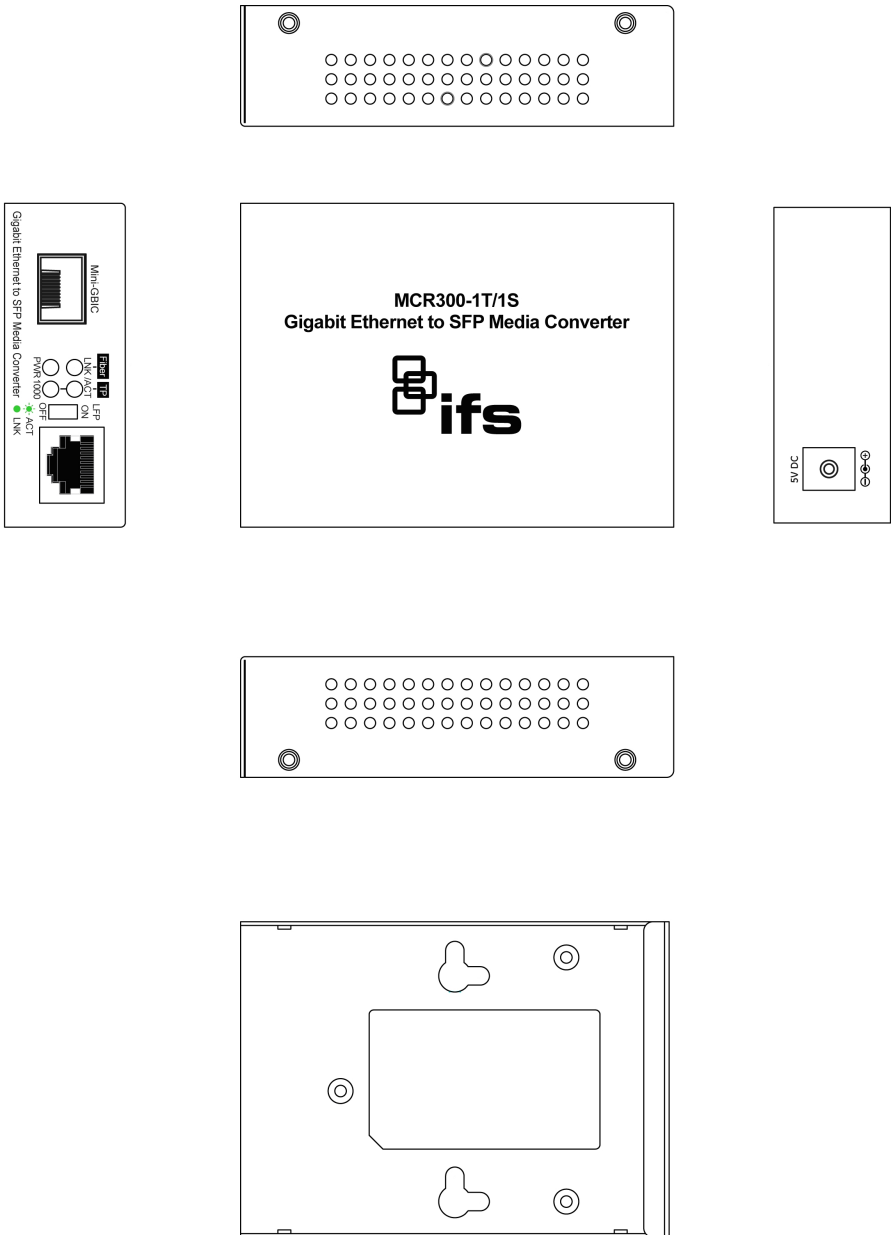

Front Panel

The Front Panel of the MCR300-1T/1S consists of one 1000Base-SX / LX mini-GBIC SFP slot and one Auto-Sensing 10/100/1000Mbps Ethernet RJ-45 Port, status LEDs and one DIP switch for LFP ON/OFF.

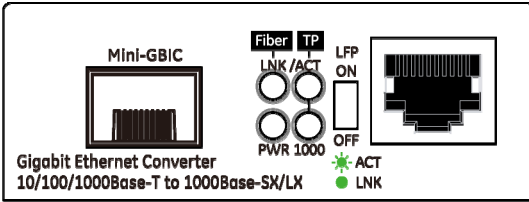

Back Panel

The back panel of the MCR300-1T/1S indicates one DC jack, which accepts input power with 5V DC 2A.



Power Notice:

This device will not work without power. For continuous functionality of the device, using an UPS (Uninterrupted Power Supply) is recommended to prevent data loss or network downtime. In some applications, installing a surge suppression device may help to protect the Gigabit Media Converter from being damaged by unregulated surge or current.

Link Fault Pass through (LFP)

The LFP refers to the Link Fault Pass Through function (LLCF/LLR) and the DIP Switch design. LLCF/LLR can immediately notify administrators about a problem with the link media. The DIP Switch enables or disables the LFP function.

LLCF (Link Loss Carry Forward) detects and the connection loss on the TP line, and LLR (Link Loss Return) detects the connection loss on the fiber line.

Link Loss Carry Forward (LLCF)

MCR300-1T/1S incorporates an LLCF function for troubleshooting a remote connection. When the LFP function is enabled, the FL/TP ports do not transmit a link signal until they receive a link signal from the opposite port.

The diagram below shows a typical network configuration with a good link status using MCR300-1T/1S for remote connectivity.

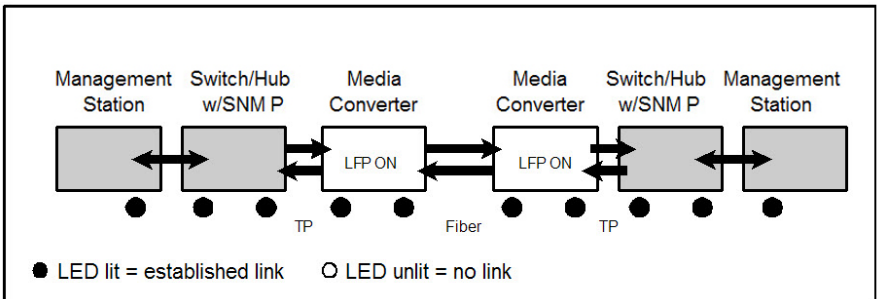

In case of a connectivity issue, the MCR300-1T/1S media converter LLCF sends the notification to the switch/hub that generates a trap to the management station.

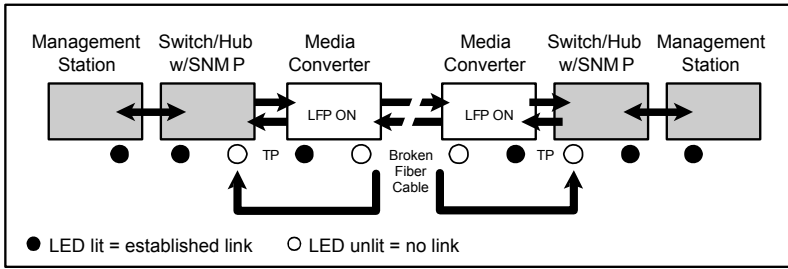

* The factory default setting for the LFP function is "off".

Link Loss Return (LLR)

The fiber ports of MCR300-1T/1S have been designed with an LLR function for troubleshooting a remote connection. LLR works in conjunction with LLCF.

When the LFP function is enabled, the port's transmitter shuts down when its receiver fails to detect a valid connection. LLR should only be enabled on one end of the link and is typically enabled on either the unmanaged or remote device.

The diagram below shows a typical network configuration with a good link status using MCR300-1T/1S for remote connectivity. Note that LLR and LLCF are enabled as indicated in the diagram.

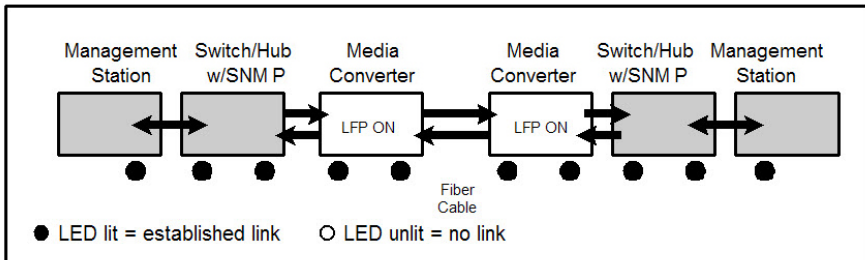

If one of the optical conductors is bad (as shown in the diagram box below), the converter with LLR function will return a no-link condition to its link partner. With LLCF function also enabled, the no-link condition is carried forward to the

switch/hub where a trap is generated to the management station.

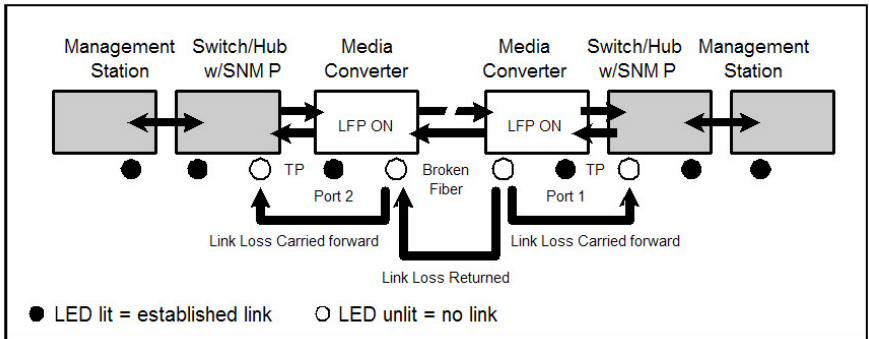

Note: The factory default setting for the LFP function "off". This feature can also be turned via the side DIP-switch. If installer is familiar with the network installation and diagnostics (i.e. checking which end is broken in a connection), you can turn the switch to on position and reset the converter for changes to take effect. Otherwise, it's recommended to keep the DIP switch in its default position.

Installing the MCR300-1T/1S

Please follow these steps to install the MCR300-1T/1S:

1. Turn off the power of the device/station in a network to which the MCR300-1T/1S will be attached.
2. Ensure that there is no activity in the network.
3. Connect the fiber cable. Attach the duplex LC connector on the network cable into the SFP transceiver.
4. Attach fiber cable from the MCR300-1T/1S to the fiber network. TX, RX must be paired at both ends.
5. Connect a 5 VDC power adapter to the MCR300-1T/1S and verify that the Power LED powers up.
6. Turn on the power of the device/station; the PWR LEDs should light when all cables are attached.

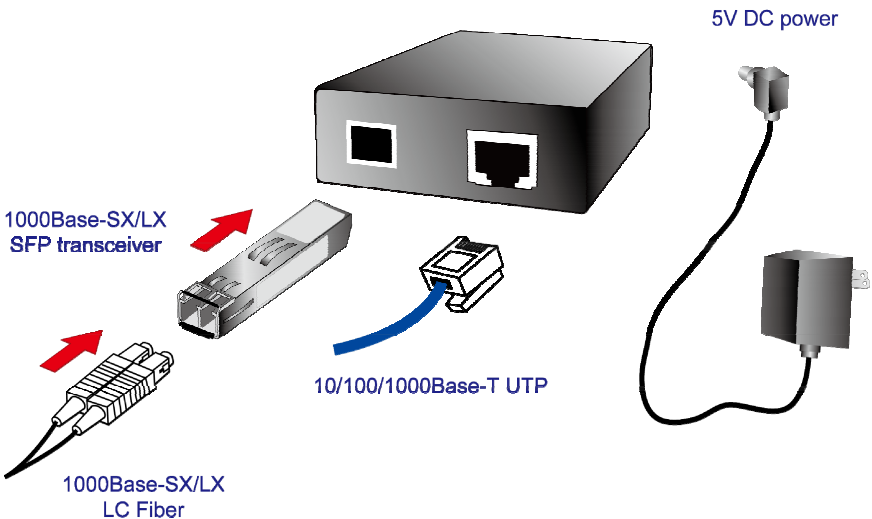

Note: It is recommended to use 1000Base-SX / LX SFP modules available in the IFS Transmission product line. A SFP transceiver module that is not supported will not be recognized by MCR300-1T/1S media converter.

Duplex Mode Support

The MCR300-1T/1S is a one-channel media converter between 10/100/1000Base-T and 1000Base-SX/LX. The 10/100/1000Base-T port can operate under Auto-negotiation mode. The 1000Base-SX/LX SFP fiber port allows only fixed 1000Mbps full duplex mode.

LED indicators

System

LED	Color	Function
PWR	Green	Lit: Indicates the device is powered.

10/100/1000Base-TX Port

LED	Color	Function
TP LNK/ACT	Green	Lit: Indicates the link through that port is successfully established.
		Blinking: Indicate that the port is actively sending or receiving data.
TP 1000	Green	Lit: Indicates a 1000Mbps Full duplex connection.
		Off: Indicates a 10/100 Mbps Full duplex connection.

1000Base-SX/LX SFP Slot

LED	Color	Function
Fiber LNK/ACT	Green	Lit: Indicates a successful link through the fiber port.
		Blinking: Indicates the data activity through the fiber port.

Cable Connection

The recommended cable types are listed below:

Cables:

Standard	Fiber Type	Cable Specification
1000Base-SX (850nm)	Multi-mode	50/125µm or 62.5/125µm
1000Base-LX (1300nm)	Multi-mode Single Mode	50/125µm or 62.5/125µm 9/125µm

Fiber Distances:

Standard	Fiber	Diameter (micron)	Modal Bandwidth (MHz * km)	Max. Distance (meters)
1000Base -SX	MM	62.5	100	220
		62.5	200	275
		50	400	500
		50	500	550
1000Base -LX	MM	62.5	5	550
		50	4	
		50	5	
	SM	9	N/A	5000*

Note:

The single mode port (1000Base-LX port) of the MCR300-1T/1S, is compliant with LX 5 kilometers and provides additional margin allowing for a 10/30/70 kilometer Gigabit Ethernet links on single mode fiber.

Specifications

The MCR300-1T/1S comes with the following standard features:

Model	MCR300-1T/1S
Connector – Fiber	SFP, LC type
Mode	Vary on module
Fiber Maximum Distance	Vary on module
Connector - Copper	10/100/1000Mbps RJ-45
Modes	Full Duplex, auto-negotiation
Packet Forwarding Rate (64bytes)	14880pps @10Mbps 148810pps @100Mbps 1488000pps @ 1000Mbps
LED indicators:	PWR, Fiber/LNK/ACT, TP/LNK/ACT, TP/1000
DIP switch	LFP function (Disable / Enable) setting
Protocols and Standards:	IEEE 802.3 10Base-T IEEE 802.3u 100Base-TX IEEE 802.3ab 1000Base-T IEEE 802.3z 1000Base-SX/LX
Cable	10/100/1000Base-T: 1000Base-T-2-pair UTP Cat. 5/5e/6, up to 100m 1000Base-SX : 50/125µm or 62.5/125µm multi-mode fiber optic cable, up to 220/550m (vary on SFP module) 1000Base-LX : 9/125µm single-mode fiber optic cable, up to 10/30/70km (vary on SFP module)
OAM	TS-1000, IEEE 802.3ah terminal
Jumbo Packet Size	9K
Dimensions	26 x 70 x 97mm (H x W x D)
Weight	0.41lbs / 190g
Power	External power adaptor 5V 2A max.
EMI Compatibility:	FCC Class A, CE Certification Class A
Temperature:	Storage: -10°C ~ 70°C / Operating: 0°C ~ 50°C
Humidity:	5% ~90% non-condensing

When connecting to other Ethernet equipment such as a Router, Bridge, Switch, or Hub, please refer to that device's Technical Manual.

RJ45 Pin Assignments

1000Mbps, 1000BaseT

RJ-45 Connector pin assignment		
Contact	MDI	MDI-X
1	BI_DA+	BI_DB+
2	BI_DA-	BI_DB-
3	BI_DB+	BI_DA+
4	BI_DC+	BI_DD+
5	BI_DC-	BI_DD-
6	BI_DB-	BI_DA-
7	BI_DD+	BI_DC+
8	BI_DD-	BI_DC-

10/100Mbps, 10/100Base-TX

RJ-45 Connector pin assignment		
Contact	MDI Media Dependant Interface	MDI-X Media Dependant Interface -Cross
1	Tx + (transmit)	Rx + (receive)
2	Tx - (transmit)	Rx - (receive)
3	Rx + (receive)	Tx + (transmit)
4, 5	Not used	
6	Rx - (receive)	Tx - (transmit)
7, 8	Not used	

RJ45 Cable Drawing

Error! Objects cannot be created from editing field codes.

The following figure shows the pin allocation and color of a straight cable, and connection of a crossover cable.

Straight Cable

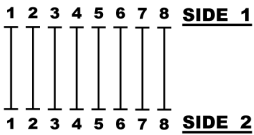

- SIDE 1**
- 1 = White/Orange
 - 2 = Orange
 - 3 = White/Green
 - 4 = Blue
 - 5 = White/Blue
 - 6 = Green
 - 7 = White/Brown
 - 8 = Brown

- SIDE 2**
- 1 = White/Orange
 - 2 = Orange
 - 3 = White/Green
 - 4 = Blue
 - 5 = White/Blue
 - 6 = Green
 - 7 = White/Brown
 - 8 = Brown

Cross Over Cable

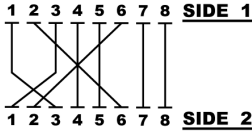

- SIDE 1**
- 1 = White/Orange
 - 2 = Orange
 - 3 = White/Green
 - 4 = Blue
 - 5 = White/Blue
 - 6 = Green
 - 7 = White/Brown
 - 8 = Brown

- SIDE 2**
- 1 = White/Green
 - 2 = Green
 - 3 = White/Orange
 - 4 = Blue
 - 5 = White/Blue
 - 6 = Orange
 - 7 = White/Brown
 - 8 = Brown

Please make sure your connected cables are with same pin assignment and color as above picture before deploying the cables into your network.

Fiber Optical Cable Connection Parameter

Fiber Optical patch Cables:

Standard	Fiber	Diameter (micron)	Modal Bandwidth (MHz * km)	Max. Distance (meters)
1000Base-SX	Multi- mode	62.5	100	220
		62.5	200	275
		50	400	500
		50	500	550
1000Base-LX	Multi-mode	62.5	5	550
		50	4	
		50	5	
	Single Mode	9	N/A	5000*

Contacting Technical Support

Contact technical support if you encounter any difficulties during this installation. Please make sure you have the requested diagnostic or log files ready before you contact us by phone or go to www.interlogix.com/customer-support.

Technical Support

Europe, Middle East and Africa

W Select *Contact Us* at www.utcssecurityproducts.eu

North America

T +1 855.286.8889

E techsupport@interlogix.com

Australia

E techsupport@interlogix.au
