

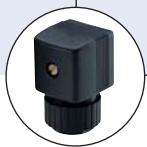

Type 0121 can be combined with...



**Type 2508**

Cable plug



**Type 1078**

Timer control

## 2/2- and 3/2-way solenoid valve for aggressive fluids

- Direct-acting, media-separated valve with diameter of up to DN 8
- Maintenance-free pivoted armature technology
- Vibration-proof, block screwed coil system
- Service-friendly, durable manual override
- Explosion proof version

The 0121 valve is a direct-acting, media-separated pivoted armature valve. It is available in 3/2- and 2/2-way versions. As a 3/2-way version, it can be used as a distributor or mixing valve. Various diaphragm material combinations and methods of operation are available depending on the application. The housing offering includes stainless steel (316L), PTFE, and PVC versions. The solenoid coils are moulded with a chemically resistant epoxy. The 0121 is equipped with manual override for commissioning and testing. For reduced energy requirements, all coils can be delivered with electronic power reduction or as an impulse version. The switching status can be indicated with position feedback as a binary or NAMUR signal. In combination with a plug in accordance with DIN EN 17301-803 Form A, the valves satisfy protection class IP65/67 – in combination with a stainless steel or plastic housing NEMA 4X.

### Content:

#### Standard version

Technical data	p. 1
Additional options	p. 3
Dimensions & Pin Assignment	p. 4
Ordering chart	p. 5

#### Explosion proof version

Technical data	p. 6
Additional options	p. 7
Dimensions & Pin Assignment	p. 8

Technical data	
<b>Orifice</b>	DN2,0 to 8,0
<b>Available housing materials</b>	PTFE PVC (resistant acc. to DIN 8062, 8061) PP (Polypropylen) PVDF Stainless steel 1.4401
<b>Seal materials</b>	FKM / FFKM / EPDM
<b>Medium</b>	
for FKM	Oxydizing acids and substances, hot oils with additives, salt solutions, waste gases
for FFKM	Aggressive fluids, hot air, hot oils, Aromate, ether, Esther, ketones (please note Bürkert chemical resistance chart). Alkalis, acids up to medium concentration, alkaline washing- and bleaching lyes
for EPDM	
<b>All Materials</b>	For more detailed information please consult the resistance chart
<b>Medium temperature for body material PVDF oder PP</b>	EPDM: -30 to +70 °C FKM: -10 to +70 °C FFKM: -10 to +70 °C
<b>Medium temperature for body material PTFE or VA</b>	EPDM: -30 to +90 °C FKM: -10 to +90 °C FFKM: -10 to +90 °C
<b>Medium temperature for body material PVC</b>	EPDM: -30 to +50 °C FKM: -10 to +50 °C FFKM: -10 to +50 °C
<b>Ambient temperature</b>	Max. +50 °C
<b>Viscosity</b>	Max. 37 mm <sup>2</sup> /s
<b>Voltages</b>	24 V 50 Hz; 110 V 50 Hz; 230 V 50 Hz; 120 V 60 Hz; 240 V 60 Hz; 12 V DC; 24 V DC; (Further voltages on request)
<b>Voltage tolerance</b>	+/- 10%
<b>Cycling rate</b>	max. 100/min with AC max. 10/min for UC (high-capacity electronic)
<b>Duty cycle for VA</b>	100%
<b>Duty cycle bei PVDF, PP and PTFE</b>	40% ED (60% intermittent operation) in 10 min bei 8 W-version 100% ED for 5 W-version or high-capacity electronic
<b>Duty cycle for PVC</b>	with PVC 10% ED (10 min) 100% ED for version with high-capacity electronic

**Circuit function**

- A** 2/2-way valve, normally closed by spring force
- B** 2/2-way valve, normally open by spring force
- C** 3/2-way valve, direct acting, when de-energised port A exhausted
- D** 3/2-way valve, direct acting, when de-energised port B pressurised
- E** Mixer valve, direct-acting, currentless P2 acc. to A open P1 closed
- F** Distribution valve, direct-acting, currentless P acc. to B open, output A closed
- T** 3/2 Wege-valve, universal function, flow direction as required

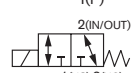
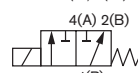
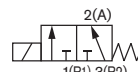
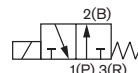
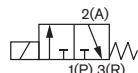
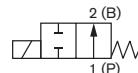
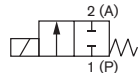
**Technical data (continued)**

<b>Electrical connection</b>	Tag connector acc. to DIN EN 175301-803 Form A for Cable plug type 2508/2509 (on request also with injected cable or terminal box)
<b>Protection class</b>	IP65 with cable plug
<b>Thermal insulation class of the coil</b>	H
<b>Installation</b>	As required, preferably with actuator upright
<b>Weight [kg]</b>	
Material VA	0,9
Material PVDF, PP und PVC	0,38
Material PTFE	0,5

**Power consumption standard**

Frequency: AC Inrush [VA]	Operation [VA]	Operation [W]	Frequency: DC	
			Cold [W]	Warm [W]
30	15	8	11	8

**Response times**

Frequency: AC Opening [ms]	Closing [ms]	Frequency: DC	
		Opening [ms]	Closing [ms]
20	11	11	8

**Response times [ms]:**

Measurement at the valve output 6 bar and +20 °C

Opening: Pressure rise 0 to 90%,

Closing: Pressure drops 100 to 10%

**Pressure range and flow rate**

Circuit function	DN	KV-value water [m³/h]	Pressure range [bar]	
			Frequency AC [50 o. 60 Hz] <sup>1)</sup>	Frequency DC <sup>1)</sup>
A / F	2	0,1	0 – 6	0 – 3
	4	0,3 <sup>2)</sup>	0 – 4	0 – 2
	6	0,6 <sup>3)</sup>	0 – 2	0 – 1
	8	1,0	0 – 1	0 – 0,8
C / D	2	0,1	0 – 3	0 – 1,5
	4	0,3 <sup>2)</sup>	0 – 2	0 – 1
	6	0,6 <sup>3)</sup>	0 – 1	0 – 0,5
	8	1,0	0 – 0,3	0 – 0,3
B	2	0,1	0 – 6	0 – 3
	4	0,3 <sup>2)</sup>	0 – 4	0 – 2
	6	0,6 <sup>3)</sup>	0 – 2	0 – 1
	8	1,0	0 – 1	0 – 0,5
E	2	0,1	0 – 3	0 – 1,5
	4	0,3 <sup>2)</sup>	0 – 2	0 – 1
	6	0,6 <sup>3)</sup>	0 – 1	0 – 0,5
	8	1,0	0 – 0,2	0 – 0,2

<sup>1)</sup> Heat output 8 W

<sup>2)</sup> Nominal size 4 mm and seal material FKM or FFKM KV-value reduces to 0,24 m³/h

<sup>3)</sup> Nominal size 6 mm and seal material FKM bzw. FFKM KV-value reduces to 0,48 m³/h

## Materials

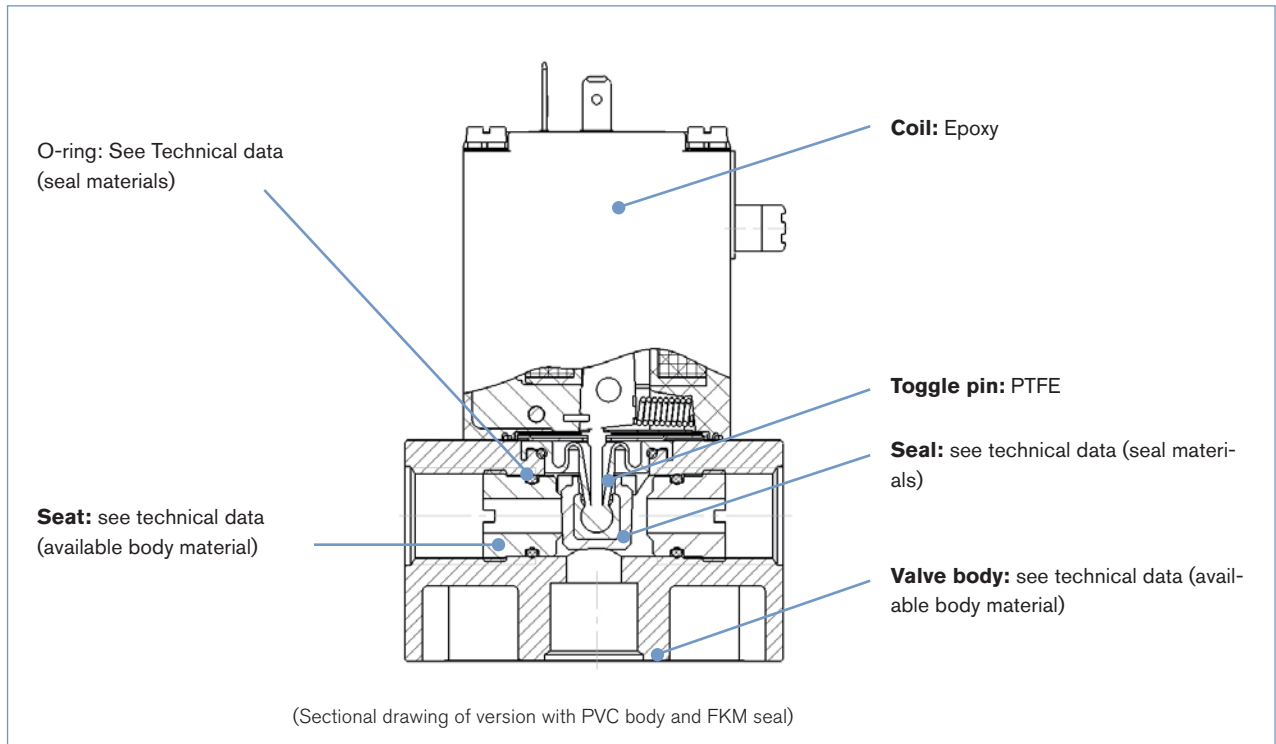

## Additional options

Option	Variable code	Specifications
Oxygen versions	NL02	Suitable for application with oxygen (non-metallic materials in contact with medium are BAM-proofed)
Higher purity requirements e.g. oil-, grease- and silicon free	NL05	Parts in contact with the medium are specially cleaned and the valves appropriate packed
Electrical feedback	LF03	See type 1060
high-capacity electronic	CZ05	Inrush power 60 W, holding current 3 W; With plastic type 100% ED feasible
Vacuum version	NA02	Suitable for vacuum up to -0,98 bar
Improved purity and tightness requirements	NA03	Parts in contact with the medium are specially cleaned and the leak test to 10 <sup>-4</sup> mbar x l / sek
Coil with reduced performance (5 W)		Devised have smaller pressure rangen; for plastic version 100% ED is achievable
Cable plug	JFxx/JGxx	Cable plug is part of the delivery. Cable plug versions (acc. to DIN EN 175301-803 Form A), see separate datasheet type 2508 and 2509
Approvals	PD02	UL recognized General Purpose valve CSA General Purpose valve
Possible conformity (depending on construction)		EAC; Drinking water; FDA

## Dimensions [mm]

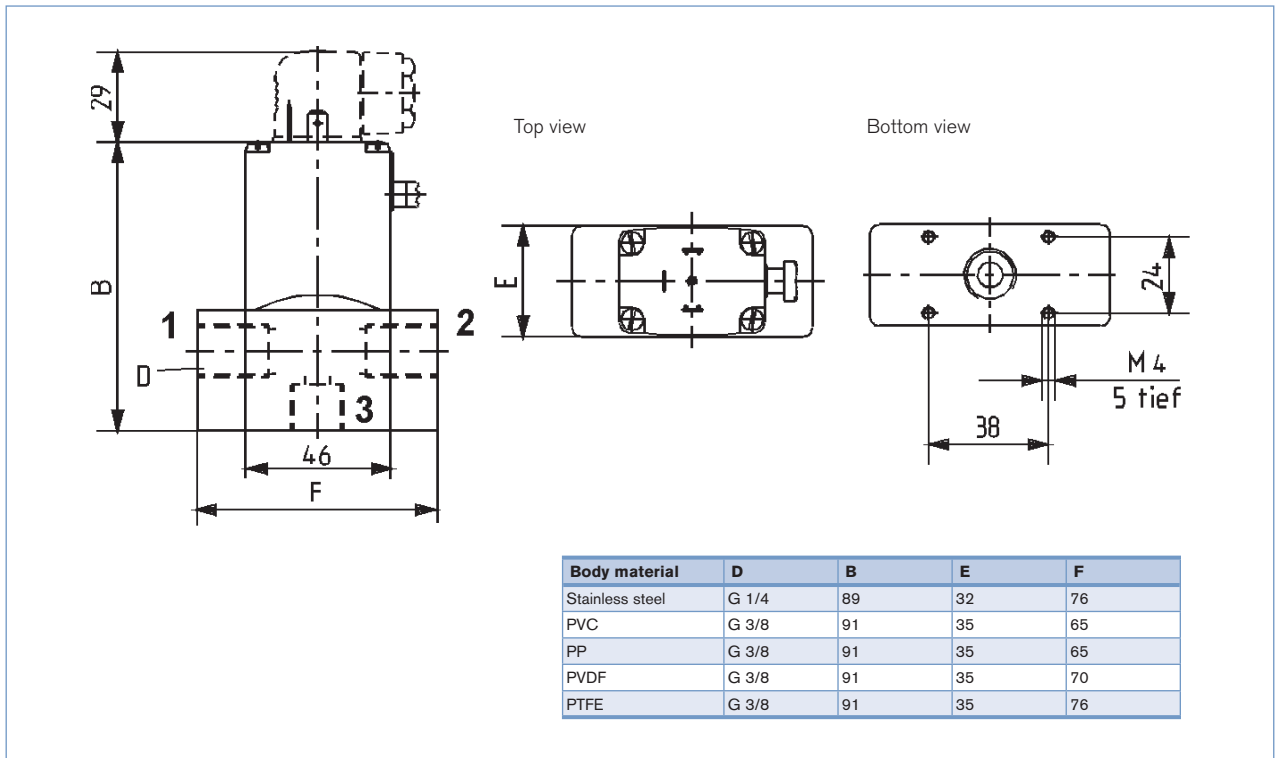

## PIN Assignments

The connections marked with 1, 2 and 3 are labelled in the drawing according to the circuit function table on the left.

Circuit function	Connection 1	Connection 2	Connection 3
A	A	P	
B	P	B	
C	P	R	A
D	R	P	B
E	P1	P2	A
F	A	B	P

Ordering chart (Articles with reduced delivery time)

Valves with plastic or stainless steel body, manual override and cable plug (UC with silicon cable, see footnote)

Circuit function	Orifice [mm]	Power connection	Seal material	Body or seat material	Item no. per voltage/frequency [V/Hz]			
					024/DC	024/50	230/50	120/60
A <sup>1)</sup>	4,0	G 3/8	FKM	PVC	049 654	048 940	047 859	-
	4,0	G 3/8	EPDM	PVC	050 795	050 085	049 267	-
	6,0	G 3/8	FKM	PVC	048 749	049 348	047 810	049 228
	6,0	G 3/8	EPDM	PVC	049 337	049 678	049 291	-
	8,0	G 3/8	FKM	PVC	049 697 <sup>3)</sup>	052 800	052 302	-
	8,0	G 3/8	EPDM	PVC	048 698 <sup>3)</sup>	050 967	050 701	450 543
	4,0	G 1/4	FKM	VA	055 244	056 934	052 441	-
	4,0	G 1/4	EPDM	VA	136 290	-	136 292	-
	6,0	G 1/4	FKM	VA	040 482	057 086	054 595	-
	6,0	G 1/4	EPDM	VA	049 113	-	-	-
	4,0	G 3/8	EPDM	PP	049 017	-	-	-
	6,0	G 3/8	EPDM	PP	052 161	-	-	-
	4,0	G 3/8	FFKM <sup>2)</sup>	PVDF	133 109	-	079 653	-
	4,0	G 3/8	FFKM <sup>2)</sup>	PTFE	122 632 <sup>3)</sup>	-	077 191	457 453 <sup>4)</sup>
	4,0	G 3/8	FFKM	PTFE	151 733	-	136 205	-
4,0	G 3/8	FFKM	PTFE	132 098 <sup>3)</sup>	-	-	-	
B <sup>1)</sup>	4,0	G 3/8	FKM	PVC	-	-	050 158	-
	6,0	G 3/8	EPDM	PVC	135 416 <sup>3)</sup>	-	-	-
	4,0	G 3/8	FFKM	PTFE	132 096 <sup>3)</sup>	-	-	-
C	6,0	G 3/8	FFKM	PTFE	132 097 <sup>3)</sup>	-	-	-
	4,0	G 3/8	FKM	PVC	051 701	-	-	-
	6,0	G 3/8	EPDM	PVC	-	-	051 577	-
	4,0	G 3/8	FFKM	PTFE	-	-	130 625	-
	4,0	G 3/8	FKM	PTFE	044 771	-	-	-
	6,0	G 3/8	FFKM <sup>2)</sup>	PTFE	131 364 <sup>3)</sup>	-	-	-
E	4,0	G 1/4	EPDM	VA	-	-	135 858	-
	4,0	G 1/4	FKM	VA	-	-	042 457	-
	6,0	G 3/8	EPDM	PVC	048 673	-	-	-
	4,0	G 3/8	FFKM <sup>2)</sup>	PVDF	-	-	120 402	-
	4,0	G 3/8	FFKM	PTFE	151 715	-	130 934	-
F	4,0	G 3/8	FFKM <sup>2)</sup>	PTFE	135 028	-	-	-
	6,0	G 3/8	FKM	PVC	049 533	052 181	047 916	-
	6,0	G 3/8	EPDM	PVC	040 062	048 760	050 491	-
	4,0	G 3/8	FFKM <sup>2)</sup>	PTFE	-	-	124 239	-
	6,0	G 3/8	FFKM	PTFE	141 134	-	-	-
6,0	G 3/8	FKM	PTFE	051 256	-	-	-	

<sup>1)</sup> The listed Item-no. and circuit functions have a housing with straight pass

<sup>2)</sup> Seal material seat seal is FFKM; Seal material seat O-ring FKM

<sup>3)</sup> The listed Item-no. are equipped with a high-performance coil (60 W-inrush, 3 W-operation) and injected cable

<sup>4)</sup> Cable plug is not part of the delivery.

Order chart for accessories

Description	Item no.
Mounting plate cpl. for DIN rail mounting	013 253 <sup>1)</sup>

<sup>1)</sup> Use only with 2/2 way globe valves

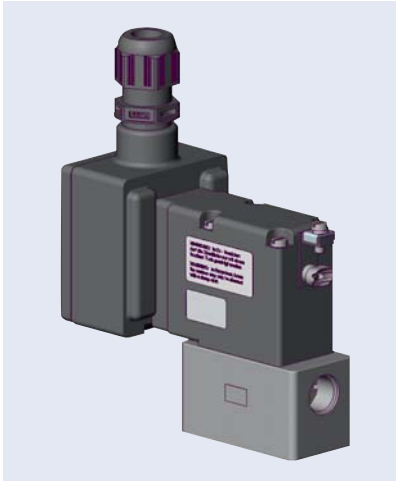

### Circuit function

- A** 2/2-way valve, normally closed by spring force
- B** 2/2-way valve, normally open by spring force
- C** 3/2-way valve, direct acting, when de-energised port A exhausted
- D** 3/2-way valve, direct acting, when de-energised port B pressurised
- E** Mixer valve, direct-acting, currentless P2 acc. to A open P1 closed
- F** Distribution valve, direct-acting, currentless P acc. to B open, output A closed
- T** 3/2 Wege-valve, universal function, flow direction as required

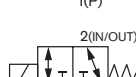
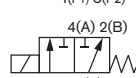
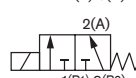
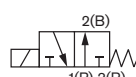
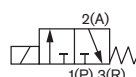
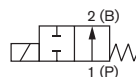
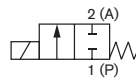

## Explosion proofed version

Technical data	
<b>Orifice</b>	DN2.0 to 8.0
<b>Available housing materials</b>	PTFE PVC (resistant acc. to DIN 8062, 8061) PP (Polypropylen) PVDF Stainless steel 1.4401
<b>Seal materials</b>	FKM / FFKM / EPDM
<b>Medium</b>	
for FKM	Oxydizing acids and substances, hot oils with additives, salt solutions, waste gases, technical vacuum
FFKM	Aggressive acids, hot air, hot oil, aromatics, ether, esther, ketones (please note Bürkert chemical resistance chart).
for EPDM	Alkalis, acids up to medium concentration, alkaline washing- and bleaching lyes
<b>All Materials</b>	For more detailed information please consult the resistance chart
<b>Medium temperature for body material PVDF or PP</b>	EPDM: -20 to +70 °C FKM: -10 to +70 °C FFKM: -10 to +70 °C
<b>Medium temperature for body material PTFE or VA</b>	EPDM: -20 to +90 °C FKM: -10 to +90 °C FFKM: -10 to +90 °C
<b>Medium temperature for body material PVC</b>	EPDM: -20 to +50 °C FKM: -10 to +50 °C FFKM: -10 to +50 °C
<b>Ambient temperature.</b>	max. +50 °C
<b>Viscosity</b>	max. 37 mm <sup>2</sup> /s
<b>Voltagess</b>	24 V; 230 V (further voltages on request)
<b>Frequency</b>	AC/DC
<b>Voltage tolerance</b>	+/- 10%
<b>Duty cycle</b>	100%
<b>Electrical connection</b>	Impressed cable (HO5RN-F3G,3x0,75 mm <sup>2</sup> ) Terminal box without safety fuse
<b>Protection class</b>	IP65
<b>Thermal insulation class of the coil</b>	H
<b>Type of protection</b>	II 2 G Ex d e IIC T4 bzw. T5 II 2 G Ex d e mb IIC T4 bzw. T5 II 2 D Ex tD A21 IP65 T135 °C bzw. 100 °C
<b>Certificate</b>	PTB 03 ATEX 1030 X IECEX PTB 05.0026 X
<b>Safety fuse</b>	Appropriate inrush current (see ordering chart)
<b>Installation</b>	As required, preferably with actuator upright
<b>Weight [kg]</b>	
Material VA	1,15
Material PVDF, PP und PVC	0,62
Material PTFE	0,75

### Cycling rate

	Max. cycling rate	For medium temperature	For ambient temperature
Version 1	20/min	Up to +70 °C	Up to +40 °C
Version 2	5/min	Up to +90 °C	Up to +40 °C

### Power consumption

Inrush [W]	Operation [W]
40	3

### Response times

Orifice [mm]	Opening [ms]	Closing [ms]
2 - 8	30	40

### Response times [ms]:

Measurement at the valve output 6 bar and +20 °C

Opening: Pressure rise 0 to 90%,

Closing: Pressure drop 100 to 10%

## Technical data (continued)

### Pressure range and flow rate

Circuit function	DN	Water KV-value <sup>1)</sup> [m <sup>3</sup> /h]	Pressure range <sup>2)</sup> [bar]
A / F	2	0,1	0 – 6
	4	0,3 <sup>3)</sup>	0 – 4
	6	0,6 <sup>4)</sup>	0 – 2
	8	1,0	0 – 1
C / D	2	0,1	0 – 3
	4	0,3 <sup>3)</sup>	0 – 2
	6	0,6 <sup>4)</sup>	0 – 1
	8	1,0	0 – 0,3
B	2	0,1	0 – 6
	4	0,3 <sup>3)</sup>	0 – 4
	6	0,6 <sup>4)</sup>	0 – 2
	8	1,0	0 – 1
E	2	0,1	0 – 3
	4	0,3 <sup>3)</sup>	0 – 2
	6	0,6 <sup>4)</sup>	0 – 1
	8	1,0	0 – 0,2

<sup>1)</sup> Measured at +20 °C, 1 bar pressure at valve inlet and free outlet.

<sup>2)</sup> Pressure data [bar]: Measured as overpressure to the atmospheric pressure

<sup>3)</sup> Nominal size 4 mm and seal material FKM bzw. FFKM KV-value reduces to 0,24 m<sup>3</sup>/h

<sup>4)</sup> Nominal size 6 mm and seal material FKM bzw. FFKM KV-value reduces to 0,48 m<sup>3</sup>/h

### Additional options

Option	Variable code	Specifications
Oxygen versions	NL02	Suitable for application with oxygen (non-metallic materials in contact with medium are BAM-proofed)
Higher purity requirements e.g. oil-, grease- and silicon free	NL05	Parts in contact with the medium are specially cleaned and the valves appropriate packed
Vacuum version	NA02	Suitable for vacuum up to -0,98 bar
Improved purity and tightness requirements	NA03	Parts in contact with the medium are specially cleaned and the leak test to 10-4 mbar x l / sek

### Recommended backup value

Voltage [V]	Max. current [A]
24	2
230	0.5
110-120	0.8

**Dimensions [mm]**

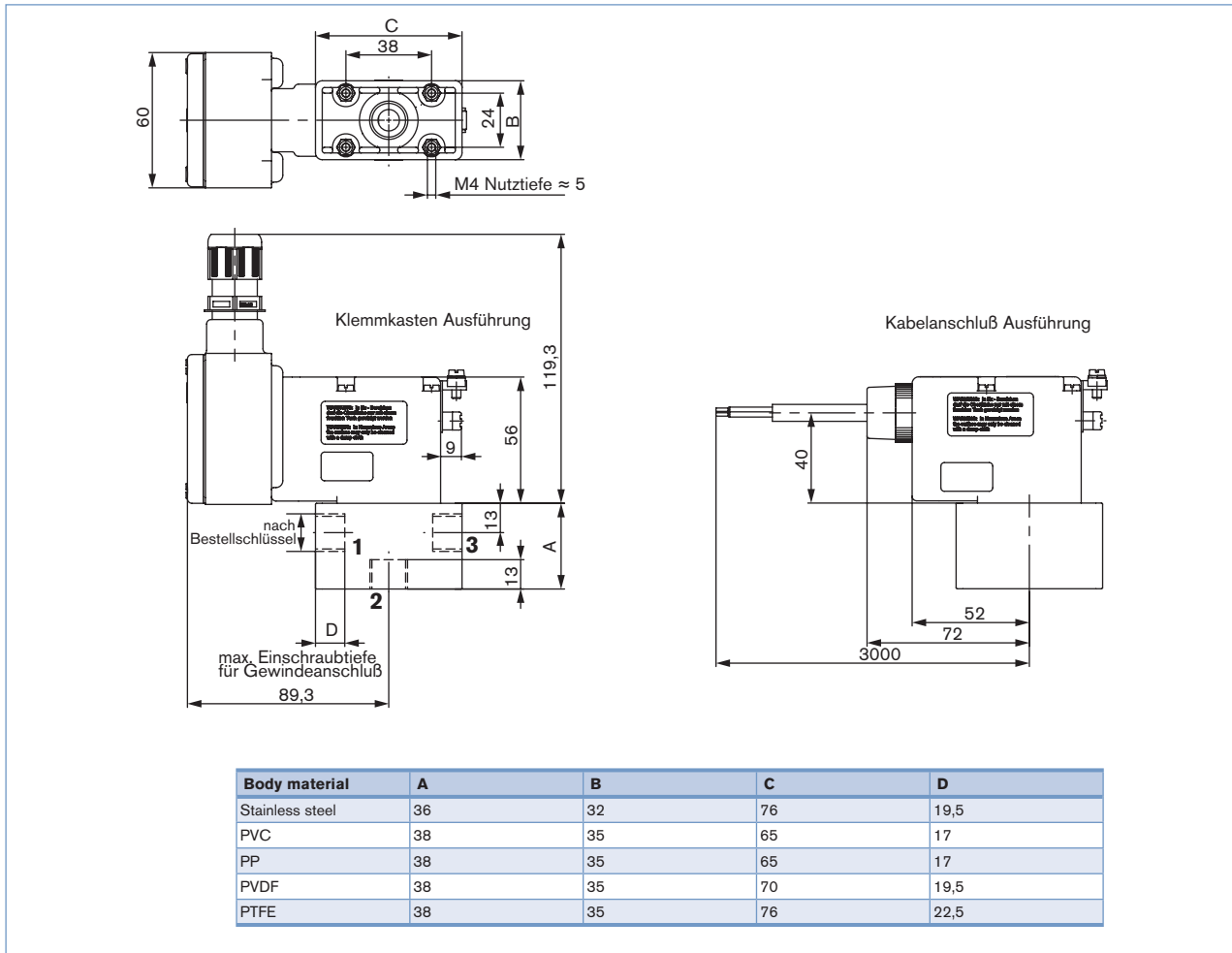

**PIN Assignments**

The connections marked with 1, 2 and 3 are labelled in the drawing according to the circuit function table on the left.

Circuit function	Connection 1	Connection 2	Connection 3
A	A	P	
B	P	B	
C	P	R	A
D	R	P	B
E	P1	P2	A
F	A	B	P

To find your nearest Bürkert facility, click on the orange box →

[www.burkert.com](http://www.burkert.com)

In case of special application conditions, please consult for advice.

Subject to alterations  
© Christian Bürkert GmbH & Co. KG

1611/7\_EU-en\_00891601