

Sample Filters

Balston Sample Filters Protect Sensitive Analyzers

Balston Gas and Liquid Sample Analyzer Filters protect analyzers from sample impurities by removing solids and liquids from gases with 99.99999+% efficiency at 0.01 micron. Balston Sample Filters offer liquid filtration to 1 micron or lower. Composed of borosilicate glass microfibers with a resin binder, Balston sample filters are inert to most any gas or liquid.

To satisfy the extremely wide range of requirements for analyzer sample filters, Parker Hannifin Corporation supplies a complete line of filter housings in stainless steel, polypropylene, and other corrosion resistant materials, as well as a choice of high efficiency filter elements which are inert to most all liquids and gases.



Product Features

- Remove liquids and solids from gas samples
- Remove solids and gas bubbles from liquid samples
- Coalesce and separate two liquid phases
- Filter solids and liquids from gases with 99.99999+% efficiency at 0.01 μm
- Temperature resistance to 900°F (482°C)
- Low pressure drop
- Long life between filter element changes

Emissions Monitoring and Analysis

Process Instrumentation and Controls

Slip Stream and By-Pass Sampling Filtration

Specialty Gas and Chemical Filtration



Sample Filters

Sample Filter Functions

Sample Filters

Coalescing Filtration: Separating Liquids From Gases

Microfibre Filter Cartridges efficiently separate suspended liquids from gases. The micro fibers capture the fine liquid droplets suspended in the gas and cause the droplets to run together to form large drops within the depth of the filter cartridge. The large drops, forced by the gas flow to the downstream surface of the filter cartridge, from which the liquid drains by gravity. This process is called “coalescing”. Since the coalesced liquid drains from the cartridge at the same rate that liquid droplets enter the cartridge, the cartridge has an unlimited life when coalescing liquids from relatively clean gases, and the filters operate at their initial retention efficiency even when wet with liquid (see Figure 1). Note that the flow direction is inside-to-outside, to permit the liquid to drip from the outside of the filter to the housing drain.

Since the coalesced liquid drips from the downstream surface of the filter cartridge in the presence of filtered gas, it is important to avoid carryover, or entrainment, of liquid droplets by the gas leaving the filter housing. The possibility of entraining coalesced liquid is minimized by using an X-Type filter cartridge. The X-Type filter cartridges are constructed of two layers, an inner high-efficiency coalescing layer and an outer layer of coarse glass fibers. The coarse, rapidly-draining outer layer ensures that the liquid drips continuously from the bottom of the filter cartridge and minimizes the chance of liquid carryover. (The small internal volume of some filter housings does not permit use of the thick-wall X-Type cartridges, and therefore Q-Type cartridges must be used.) Re-entrainment of coalesced liquid is also avoided by ensuring that the gas flow rate through the housing is safely below the maximum shown in the flow charts on page 40. For most requirements for removing liquid from gas samples, Grade DX or DQ filter cartridges should be used.

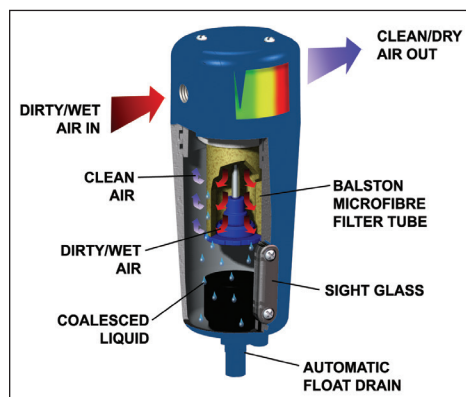

Figure 1
Balston Compressed Air Filter

Draining Collected Liquid

If liquid is carried into the filter in slugs rather than dispersed as droplets in the gas, a filter which is properly sized for steady-state conditions can be flooded and permit liquid carryover. If slugging of liquid is expected, a filter with a relatively large bowl should be selected to provide adequate liquid holding capacity and provisions should be made to drain the liquid automatically from the bowl of the housing as fast as it accumulates. An automatic float drain can be used if the pressure is in the 10-400 psig (0.69-28 barg) range. Above 400 psig (28 barg), the possibilities are: a constant bleed drain, a valve with automatic timed actuator (supplied by customer), or an external reservoir with manual valves (see Figure 2). The external reservoir can be constructed of pipe or tubing with sufficient volume to hold all the liquid which is expected to be collected during any period of unattended operation.

If the filter is under vacuum, the external reservoir is a practical method of collecting coalesced liquid for manual draining from time to time. If an external vacuum source, such as an aspirator, is available, the liquid may be drained continuously from the housing drain port.

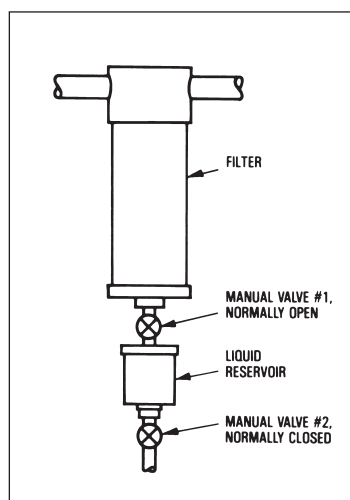

Figure 2
To drain liquid while filter is operating at pressure or vacuum conditions, close valve #1, and open valve #2

Sample Filters

Sample Filter Functions

Coalescing Filtration: Separating Two Liquid Phases

In principle, Microfibre Filter Cartridges separate suspended droplets of a liquid which is immiscible in another liquid by the same process as they separate droplets of liquid from a gas. The liquid droplets suspended in the continuous liquid phase are trapped on the fibers and run together to form large drops, which are then forced through the filter to the downstream surface. The large drops separate from the continuous liquid phase by gravity difference, settling if heavier than the continuous phase and rising if lighter. The coalescing action of Balston® filters is effective with aqueous droplets suspended in oil or other hydrocarbons, and also with oil in water suspensions.

In practice, liquid-liquid separations are much more difficult than liquid-gas separations. The specific gravity difference between two liquids is always less than between a liquid and a gas, and therefore a longer phase separation time is needed. Either the filter housing must be oversized or the flow rate greatly reduced to avoid carryover of the coalesced phase. As a rule of thumb, flow rate for liquid-liquid separation should be no more than one-fifth the flow rate for solid-liquid separation shown in the chart on page 77. Even at low flow rates, if the specific gravity difference between the two liquids is less than 0.1 units (for example, if an oil suspended in water has a specific gravity between 0.9 and 1.1), the separation time for the coalesced phase may be impractically long. In that case, if there is only a small quantity of suspended liquid, the filter tube can be used until saturated with the suspended liquid and then changed.

Another practical problem with liquid-liquid separations is that small quantities of impurities can act as surface-active agents and interfere with the coalescing action. For that reason it is not possible to predict accurately the performance of a liquid-liquid coalescing filter, and each system must be tested on site. The general guidelines for the system to start testing are to use Grade DX filter cartridges, and flow inside-to-outside at very low flow rates. If the suspended liquid is lighter than the continuous phase, the housing should be oriented so that the drain port is up. In general, Microfibre Filter Cartridges should be used for liquid-liquid coalescing in slipstream sampling applications only.

Membrane Separation of Sample Streams

A Coalescer Membrane Combination Filter is designed to remove entrained liquid and particulate in gas samples for a wide variety of applications, and to prevent contamination or damage to the analyzers and sample system components. Microscopic pores contained within the membrane permit molecules of gas or vapor to flow through easily, allowing the composition of the sample gas to remain unchanged. However, even the smallest liquid molecules remain trapped and are unable to flow through the membrane's small passages under normal operating conditions. This is due to the high surface tension which causes liquid molecules to bind tightly together to form a group of molecules, moving together, which is too large to fit through the pores of the membrane.

The membrane is extremely inert, and is recommended for most process liquid applications, with the exception of hydrofluoric acid. It is also recommended for use in systems designed for PPB, PPM, and "percent level" component concentrations, as a result of its very low absorption characteristics. The membrane is strong and durable, but also very soft and pliable. Typically located upstream from the analyzer or component it is protecting, the Coalescer Membrane Combination provides protection even if other sample system components fail.

Removing Gas Bubbles from Liquids

Microfibre Filter Cartridges readily remove suspended gas bubbles from liquid, eliminating the need for deaeration tanks, baffles, or other separation devices. Flow direction through the filter is outside-to-inside. The separated gas bubbles rise to the top of the housing and are vented through the drain port. If slipstream sampling is used, the separated bubbles are swept out of the housing with the bypassed liquid. Grade DX or Grade DQ is a good choice for gas bubble separation.

Sample Filters

Sample Filter Functions

Quantitative Measurement of Solids in Gas

Quantitative determination of solids in gas, often a requirement in stack gas or other exhaust gas sampling, is readily accomplished using a Balston® Model 30 filter housing. In the Model 30 housing, the filter cartridge is sealed in place by a stainless steel spring acting on a lightweight stainless retainer disc (Figure 3). The retainer disc is pressed firmly into the end of the filter cartridge. When the housing is disassembled, the filter cartridge and retainer disc may be easily removed as a unit. At the beginning of the run, a tare weight is obtained on the filter cartridge-retainer disc assembly. When the filter is in service, flow through the filter cartridge is inside-to-outside so that even large solid particles which fall off the filter cartridge are held in the cartridge-disc assembly. At the conclusion of the run with a known volume of gas, the cartridge-disc assembly is reweighed, and the increase in weight can be expressed as solids concentration in the gas. Grade DH Filter Cartridges are recommended for high temperature sampling (up to 900°F/482°C). If the sampling or oven-drying temperatures do not exceed 300°F (149°C), Grade DQ may be used.

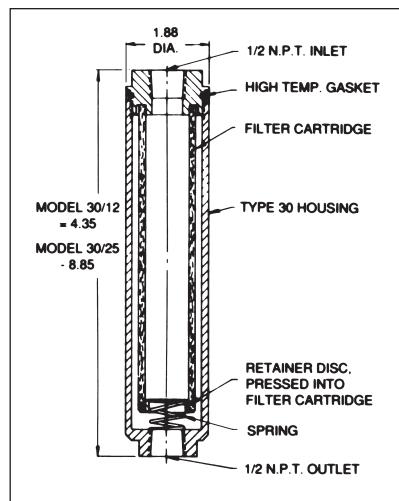

Figure 3

Filter cartridge and retainer disc of Model 30 housing may be weighed as a unit for quantitative determination of solids in gases.

Slipstream or Bypass Sampling

Instrument sample use rates are invariably quite low, yet it is essential to minimize lag time in the sample system. Since analyzers often are located some distance from the sampling point, samples are usually transported to the analyzer at a relatively high flow rate to minimize lag time. The sample is divided at the analyzer, with the analyzer using the portion it requires (usually a very small fraction of the total sample), and the balance recycled to the process, or vented.

If the sample filter is located in the low-flow line to the analyzer, it will have good life between filter element changes because the solids loading rate is very low; however, the filter must be carefully selected to avoid introducing unacceptable lag time. If the filter is located in the high-flow portion of the sample system, its effect on sample lag time can be relatively low, but the life between filter changes may be inconveniently short because the element is filtering a much greater volume of material than the analyzer is using.

Ideally, a filter should be located at the point where the low-flow stream is withdrawn to the analyzer (Figure 4). This arrangement permits the main volume of the filter to be swept continuously by the high flow rate stream, thus minimizing lag time; at the same time, only the low-flow stream to the analyzer is filtered, thus maximizing filter life.

A slipstream filter requires inlet and outlet ports at opposite ends of the filter element to allow the high flow rate of the by-passed material to sweep the surface of the filter element and the filter reservoir, and a third port connected to the low flow rate line to the analyzer, which allows filtered samples to be withdrawn from the filter reservoir.

The Model 95 housings, 31GCFL, 41GCFL, 48S6, 49S6, DFU 8822-11, and DFU 8833-11 are ideal designs for slipstream sampling, since the inlet and the bypass ports are located at opposite ends of the housing, and the bypass port is as large as the inlet port. Larger housings, such as the Model 33S6, Model 45S6, and Model 27/35, can also be used for slipstream sampling, but the relatively small size of the drain port may limit the slipstream rate in some applications.

If bubble removal from a liquid is a requirement, this function may be combined with slipstream filtration, since the recommended flow direction for bubble removal is outside-to-inside, and the separated bubbles will be swept out of the housing by the bypass stream. In this case, the liquid feed should enter at the bottom of the housing and the bypass liquid exit at the top of the housing.

Sample Filters

Sample Filter Functions

Slipstream Sampling Plus Coalescing Filtration

A special problem arises in slipstream sampling if the filter is to coalesce and continuously drain suspended liquid from a gas stream or to coalesce liquid droplets from a liquid stream. As noted earlier (see page 32), the coalesced liquid is removed in the form of large drops from the downstream side of the filter. Therefore, the coalescing filter requires two outlet ports, one for the dry gas and one for the liquid drain. To combine coalescing and slipstream filtration, a filter housing would need four ports - two for inlet and bypass and two for filtered gas and coalesced liquid - which is not a practical design. Therefore, slipstreaming plus coalescing requires two stages of filtration (Figure 5). The second (coalescing) stage must be located in the sample line to the analyzer, and should be as small as possible to minimize lag time. If the quantity of suspended liquid is not large, an in-line Disposable Filter Unit (9933-05 or 9922-05) may be considered as a trap for the suspended liquid, to be replaced when saturated.

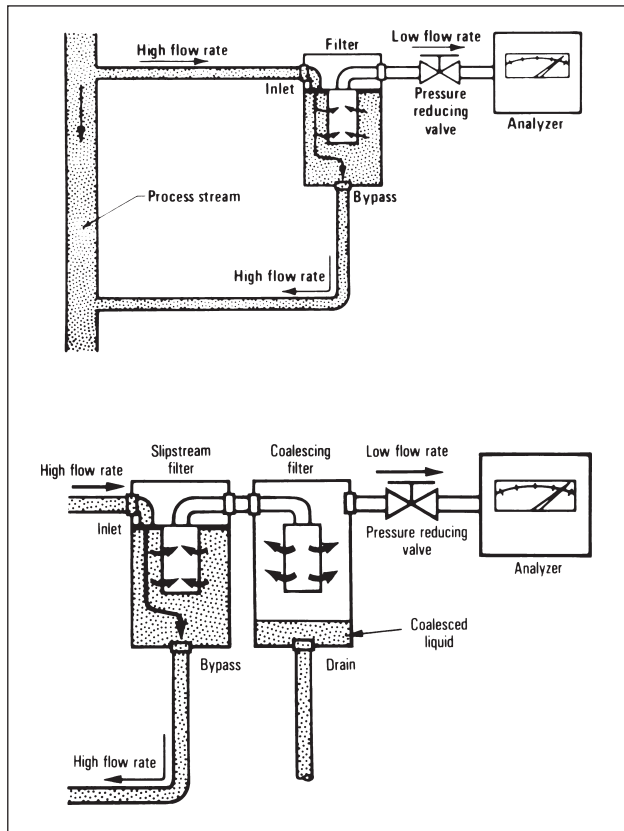

Figure 4
Slipstream or
bypass filtration

Figure 5
Slipstream Filtration
plus coalescing
filtration

Quantitative Measurement of Liquids in Gas

Quantitative determination of nonvolatile liquids suspended in a gas may be accomplished by a procedure similar to the solids determination (see page 68). In the case of liquids, the test is designed so that all the liquid entering the filter cartridge during the test period remains trapped on the fibers; i.e., the sample period is short enough that the filter cartridge does not become saturated and begin to drain liquid.

Any convenient filter housing may be used. The filter cartridge should be Grade BQ, to assure quantitative retention of aerosols, no matter what droplet size. With a known gas flow rate and test duration, the increase in weight of the filter cartridge will be a measure of the weight concentration of aerosol in the gas.

Considerable care must be taken to obtain a representative sample of aerosol in gas. If sampling from a large line, the sample probe should enter the pipe from above and if possible, extend into the pipe to avoid picking up liquid clinging to the wall of the pipe. There should be no valves, reducers, or sharp elbows in the sample line upstream from the filter.

Sample Filters

Application Recommendations

Acid Plant Stack Gas

A frequently encountered sampling requirement is to analyze the gas composition in the exhaust from absorbers or scrubbers in acid manufacturing plants. The exhaust gas invariably contains droplets of dilute acid, which must be removed from the sample before it enters the analyzer. The recommendations are similar to those for natural gas sample filtration: Grade DQ or DX filter tube, inside-to-outside flow, and two stages of filtration if slipstream sampling is required. Depending upon the composition of the suspended liquid, housings may be stainless steel, PTFE (Model 95T), Monel (Model 95M), or PVDF (DFU 8822-11).

Sampling Ambient Air or Other Atmospheric Pressure Gas

The filtration requirement for ambient air samplers is usually to remove solid particles or liquid droplets which could deposit on analyzer optical surfaces or cause other calibration problems. Grade DX or DQ filter cartridges are recommended. For low flow rate personal samplers, the compact and lightweight DFU 9933-05-DQ is often used. For higher flow rates, the Model 90 filter holder with Grade DX or DQ filters is recommended.

Ambient air sampling systems are often under negative pressure, induced by the sampling pump. If it is necessary to drain coalesced liquid from the system, the external reservoir is often the most convenient method (see Figure 2 on page 66).

Sampling Water

Most water analyzers are well protected against the damage or calibration drift caused by solid contamination if a 10 micron (LP Grade 30) filter cartridge is used. If long filter life is desired in a system with high solids loading (including most tap water, well water, and cooling water), a two stage LP cartridge system is recommended: LP Grade 10 followed by LP Grade 30.

Sampling Liquid Effluent Streams

Liquid effluent analyzers usually deal with aqueous streams having a high solids content. In addition, the analyzers are often located in remote areas of the plant and are infrequently serviced. Therefore, the sample filter system must have long life between filter cartridge changes, even in a high solids situation. The general recommendation for this requirement is a two stage filter system, LP Grade 10 filter cartridge followed by LP Grade 30 filter cartridge. The filters should be oversized as much as possible without causing excessive lag time. Plastic filter housings are usually a good choice.

Measurements of steam and condensate conductivity, specific ion concentrations, and feedwater additive concentrations are often required in high pressure boiler systems. In a continuous sampling system, the high pressure steam or condensate is cooled to below 100°F (38°C) and then the pressure is reduced to near atmospheric pressure for metering to the analyzers. Filtration is required upstream from the pressure reducing valves, to prevent pitting of the valve seats by suspended particles and to eliminate variations in flow rate to the analyzers.

A stainless steel filter housing with the appropriate pressure rating and Grade DX or DQ filter cartridge is recommended. Since the analyzer system is often located some distance from the sampling point, slipstream filtration is usually required. Figure 9 shows a sampling system in operation at a nuclear steam generating facility.

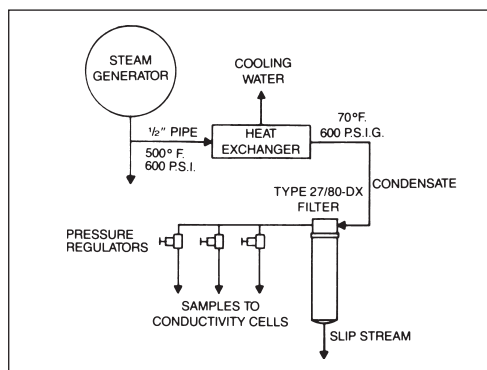

Figure 9

Model 27 filter with Grade DX filter cartridge protects pressure reducing valves in a steam condensate sampling system.

Sample Filters

Application Recommendations

On-Line Process Analyzers

The variety of filtration requirements for on-line process analyzers precludes making general recommendations above for the required filtration functions. The filter housings most frequently used for process analyzer applications are the Model 95S6 and Model 91S6, which provide the corrosion resistance of Model 316 stainless steel (complies with NACE specification MR-01-75), a pressure rating of 5000 psig (345 barg), have full slipstream sampling capability, and minimum internal volume.



Figure 6
Model 95S6, 316 stainless steel with 5,000 psig pressure rating, is the filter housing most frequently used in process analyzers

Natural Gas Analyzers

To protect gas composition analyzers from liquids and solids, Grade DX or DQ filter tubes are recommended, with inside-out flow direction. If both slipstream sampling and coalescing are required, a two stage system must be used, as described on page 75.

The Model 85, 5000 psig (345 barg) rating and Model 37, 4000 psig (276 barg) rating housings comply with NACE specification MR-01-75. For lower pressure applications, any stainless steel housing of appropriate flow capacity may be used.



Figure 7
Model 85 (left) or Model 37/12 (right) are used for natural gas sample filtration when a housing larger than the Model 95S6 is required

Stack Gas Sampling

The Model 30 housing with Grade DH filter cartridge is used for quantitative determination of solids in stack gas, as described on page 68. The Model 30 may also be used as a beginning-of-the-line filter at stack gas temperature up to 900°F (95°C), to prevent solids from entering the gas sample line. Grade DH is used for this purpose. After the sample is cooled, a coalescing filter with Grade DX tube is used to remove suspended liquids before the sample goes to the analyzer. Flow direction is inside-to-outside. Model 33G or 45G housings are often used in this application to permit a visual check on the liquid level in the filter housing. Since there often is a considerable amount of liquid present at this point, positive steps must be taken to drain the housing to ensure that liquid does not build up and carry downstream to the analyzer.

The coalescing filter should be located as close to the analyzer as possible to minimize the chance of condensation between the filter and the analyzer. Additional precautions which can be taken to avoid downstream condensation are to cool the sample below ambient temperature upstream from the coalescing filter, and to heat the line.

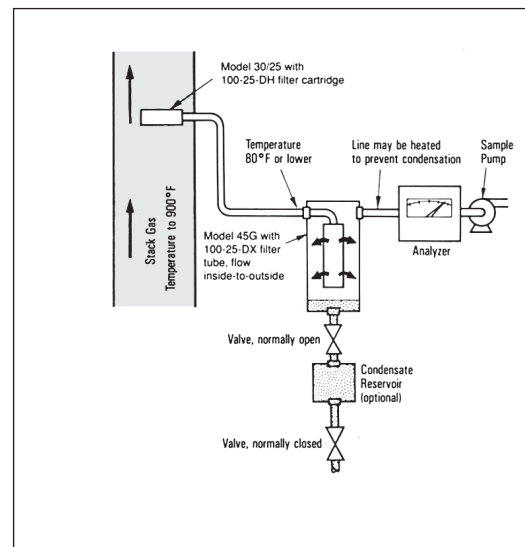

Figure 8
Stack gas sample lines usually require a high temperature solids filter at the sample point and a condensate separator immediately upstream from the analyzer

Sample Filters

Filter Cartridge and Housing Selection

Table 1 Filter Cartridge Description

LP Cartridges:	Designed to filter liquids with high solids contents. Have an integral prefilter and an external support structure (flow direction is inside-to-outside).
X-Type Cartridges: Coalescing	Used for solids and relatively large amounts of suspended liquids in gases. Provide excellent chemical resistance, temperature resistance to 300°F (150°C), and good mechanical handling properties. These cartridges have thick walls for improved coalescing efficiency. Should be used whenever permitted by housing internal volume. Fluorocarbon Resin Binder.
Q-Type Cartridges: Particulate	Used for solids and trace amounts of liquids in gases. Also ideal for liquid service and removal of particulates. Similar to X-Type cartridges in chemical and temperature resistance. Fluorocarbon Resin Binder.
S-Type Cartridges: Particulate	Used for solids and trace amounts of liquids in gases. Also ideal for liquid service and removal of particulates. Improved chemical and temperature resistance properties over Q-Type. PTFE Resin Binder. Max temp 500°F.
H-Type Cartridges: Particulate	Recommended for oxygen service or when X-Type or Q-Type are unsuitable. H-Type cartridges have temperature resistance to 1000°F (538°C) in dry gas, 100°F (38°C) in liquid. Quartz construction.
M Type Sintered Stainless Steel Cartridges: Particulate	Designed for applications having heavy loading of solid contaminants. These cartridges are also suitable for removing heavy, viscous liquids from gases and as prefilters to high efficiency final filters. Constructed of 316 stainless steel with molded viton end seals.
CI Cartridges: Vapor Adsorption	Used to remove trace quantities of oil vapor. Activated carbon sandwiched between two layers of microfiber filter media absorbs oil vapor. Must be prefiltered with Grade DX and Grade BX. Max. operating temp. is 180°F/82°C.

Filter Cartridge Description

Parker Hannifin supplies filter cartridges in three different designs: LP Cartridges, Sintered Stainless Steel Cartridges, and Microfibre Filter Cartridges (X, H, or Q-type). See Table 1 for descriptions:

How To Select The Filter Cartridge

- 1 When selecting a cartridge, do not overspecify. Select the coarsest grade which will adequately protect the instrument. Coarser grade filters provide lower pressure drop and longer life than finer grades.
- 2 When selecting X, Q, or H type cartridges, a D or B positioned before the cartridge type will determine the retention efficiency (see chart to the left). For LP and Sintered Stainless Steel Cartridges, the numerical Grade value indicates retention efficiency (see Table 2).

Refer to the chemical compatibility chart on page 38 to confirm compatibility of the filter cartridge material with the sample composition.

Table 2 Retention Efficiency of Filter Cartridges for Gas and Liquid Sample Filtration

Gas Filtration at 0.01 µm	
Microfibre Filter Cartridges	
Grades DX, DQ, DH, DS	93%
Grades BX, BQ, BH, BS	99.99%
Grade AQ	99.9999+%
Grade AAQ	99.99999+%
Liquid and Gas Filtration at Indicated Micron Size	
Sintered SS Cartridges	
Grade 5M	5 µm Nominal
Grade 10M	10 µm Nominal
Grade 20M	20 µm Nominal
Grade 40M	40 µm Nominal
Grade 70M	70 µm Nominal
Grade 00M	100 µm Nominal
Liquid Filtration (98% retention)	
Microfibre Filter Cartridges (98% retention)	
Grades DX, DQ, DH, DS	25 µm
Grades CX, CQ, CH, CS	8 µm
Grades BX, BQ, BH, BS	2 µm
Grade AQ	0.9 µm
Grade AAQ	0.3 µm
LP Cartridges (80% retention)	
Grade 10	75 µm
Grade 20	25 µm
Grade 30	10 µm
Grade 50	1 µm

How To Select The Filter Housing

- 1 Select a filter housing in the material appropriate for your application. Please refer to the Application Index on page 76, and the appropriate data sheet.
- 2 Select a filter housing with a port size equal to the line size where the filter is to be located. If the line size at the filter has not yet been selected, determine the gas flow rate and pressure at the point where the filter will be located, and refer to the appropriate flow chart on pages 77 and 78 of this bulletin. Flow rates for liquids are located on page 77 and flow rates for air and gas sample filters are located on page 78.

Sample Filters

Vapor Adsorption Cartridges

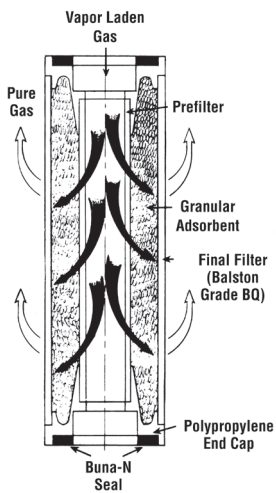

Type CI Vapor Adsorption Cartridges contain a bed of adsorbent granules in the annular space between two Microfibre Filter Tubes, with permanently bonded end caps. Utilizing a wide choice of adsorbents, the Type CI cartridges selectively remove vapors from air and other gases. Flow direction is inside-to-outside through the cartridge, and the outer Microfibre Filter cartridge serves as an integral final filter to prevent carryover of adsorbent particles.

For low flow applications, Disposable Adsorption Units (DAU) provide a means of utilizing the same choice of adsorbents used in the Type CI cartridges in a completely disposable package.

Because the absorbed vapor remains trapped in the solid bed, the Type CI cartridge has a fixed upper limit of total weight of vapor which can be captured. It is usually not feasible to regenerate the cartridge when it has reached its adsorption limit. Type CI cartridges should be used only when small quantities of vapor are to be removed.

Adsorbents used in Type CI Cartridges

Adsorbent	Grade No.	Use For
Carbon	000	Compressor oil vapors, C ₅ and heavier hydrocarbons, aromatics, oxygenated hydrocarbons, chlorinated organics, freons, carbon disulfide.
Molecular Sieve Type 13X	103	Most C ₄ and lighter hydrocarbons, ethylene, propylene, acetylene, ethylene oxide, ammonia, mercaptans, sulfur hexafluoride, triethylamine, and smaller amines.
Mixed Sodium and Calcium Hydroxides	107	all acidic gasses, including sulfur trioxide, sulfur dioxide, nitrogen dioxide, carbon dioxide, hydrogen sulfide, hydrogen chloride, phosphorus trichloride, boron trifluoride.

Considerations in Using Adsorbent Cartridges

The following factors should be considered when selecting a vapor adsorbent cartridge:

- 1 Solid adsorbents are effective only for vapors. Since liquids will damage or inactivate most solid adsorbents, the Type CI cartridge or DAU must be preceded by an efficient coalescing filter.
- 2 In contrast with Microfibre Filters, which operate at their initial efficiency throughout their life, adsorbent cartridges have a limited holding capacity. When the adsorption capacity is reached, no further adsorption occurs. The limiting capacity, or "break-through" point, is not sharply defined, and the exit vapor concentration will increase rapidly as saturation is approached. To avoid unwanted vapor contaminants downstream, it is necessary to change the adsorbent cartridge well before it has reached its ultimate adsorption capacity.
- 3 Adsorption is reversible, if operating conditions change, a vapor may desorb rather than adsorb. For example, if a temporary surge in vapor impurity concentration causes a relatively high concentration to be absorbed on the solid, a subsequent decrease in inlet vapor composition will result in desorption of vapor from the solid to the gas stream.
- 4 The efficiency of a given adsorbent for a given vapor depends upon the specific operating conditions. Therefore, again in contrast to filtration, it is not possible to assign a single efficiency rating to an adsorbent. While it is not possible to predict or guarantee an adsorption efficiency for any specific set of conditions, it is possible to enhance the conditions beneficial to adsorption and avoid conditions which interfere with adsorption. Conditions which aid adsorption are: low temperature, high pressure, low flow rate, and absence of competing vapors (particularly water vapor).

Sample Filters

Stainless Steel Sintered Metal Filter

Remove solids and liquids from gas samples

Remove solids from liquid samples

Filtration efficiencies from 5 to 100 micron

316L stainless steel construction

Long life, cleanable filter cartridges

Temperature resistance to 400°F (204°F)

Up to 200 psid (14 barg) (differential pressure)

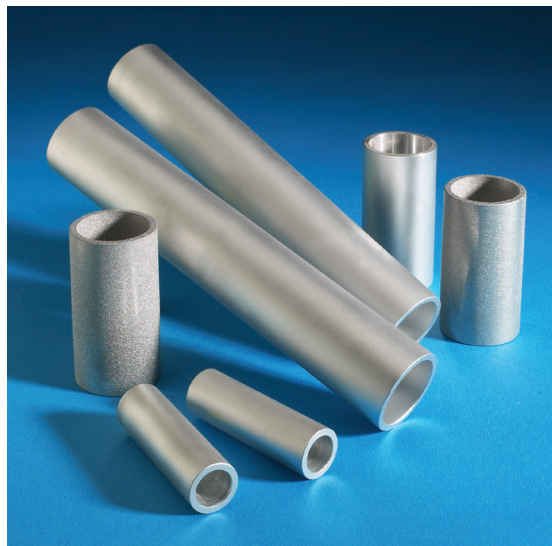

Advantages

The Balston Stainless Steel Sintered Metal Filter is suitable for applications which require a durable, low maintenance reusable stainless steel filter. The filter cartridge is constructed of 316 stainless steel with two molded Viton gaskets. It may be installed in select Balston filter housings which are designed to accommodate an 050-11, 100-12, and 100-25 size filter cartridge. The Balston Stainless Steel Sintered Metal Filters may be used in liquid or gas service, to filter particulate sized from 5 micron to 100 micron, depending on the grade of the filter used.

The Balston Stainless Steel Sintered Metal Filter has excellent chemical resistance characteristics.

Installation of the Balston Stainless Steel Sintered Metal Filter is straightforward and requires approximately 2-3 minutes. First, remove the filter bowl from the filter housing into which the filter will be installed. Next, place the molded Viton gaskets on to the ends of the cartridge. For 050-11 elements, make sure the shoulder of the gasket fits snugly onto the outer diameter of the cartridge. Finally, holding the gaskets in place on the cartridge, slide the cartridge on the support core or tie rod of the housing, and reassemble the filter housing.

Check the filter housing for leaks after reassembling.

The Balston Stainless Steel Metal Filter Cartridge should be removed from service and cleaned annually, or when the pressure drop across the filter is significant enough to adversely affect the user's application.

The cartridge may be cleaned by backflushing or ultrasonic methods. After cleaning, visually inspect the filter cartridge to confirm it's integrity for continued service.

Applications

Samples with heavy loading of solid contaminants

Removal of heavy, viscous liquids from gas samples

Prefilters to final high efficiency filters

Ideal for sample lines that are periodically back-flushed

High temperature applications

Sample Filters

Stainless Steel Sintered Metal Filter

Sample Filters

Flow Rates (SCFM/Nm³/hr) Flow Rates, SCFM (barg), at 2 psi (0.14 bar) drop at indicated line pressure, psig (barg)

Filter Housing Model	Filter Size	Filter Cartridge Grade	Filter Porosity (Micron)	Max											
				2 psig/ 0.3 barg	20 psig/ 1.3 barg	40 psig/ 2.8 barg	60 psig/ 4.1 barg	80 psig/ 5.5 barg	100 psig/ 6.9 barg	125 psig/ 8.6 barg	160 psig/ 11 barg	200 psig/ 13.8 barg	250 psig/ 17.2 barg	300 psig/ 20.7 barg	500 psig/ 34.5 barg
95, 85, 91, 48S6 Series	050-11	05M	5	0.8 (1.4)	1.6 (2.7)	2.6 (4.4)	3.6 (6.1)	4.4 (7.5)	5.4 (9.2)	6.6 (11.2)	7.8 (13.3)	10 (17.0)	12 (20.4)	15 (25.5)	24 (40.8)
			10	1.2 (2.0)	2.4 (4.1)	3.9 (6.6)	5.4 (9.2)	6.6 (11.2)	8.1 (13.8)	9.9 (16.8)	12 (20.4)	15 (25.5)	19 (32.3)	22 (37.4)	36 (61.2)
	100-12	05M	20	1.6 (1.6)	3.2 (3.2)	5.2 (5.2)	7.2 (7.2)	8.8 (8.8)	11 (11.0)	13 (13.0)	16 (16.0)	20 (20.0)	25 (25.0)	30 (30.0)	48 (48.0)
			40	2.4 (4.1)	4.8 (8.2)	7.8 (13.3)	11 (18.7)	13 (22.1)	16 (27.2)	20 (34.0)	23 (39.1)	31 (52.7)	37 (62.9)	44 (74.8)	73 (124.0)
			70	3.4 (5.8)	6.8 (11.6)	11 (18.7)	15 (25.5)	19 (32.3)	23 (39.1)	28 (47.6)	33 (56.1)	43 (73.1)	53 (90.0)	63 (107.0)	103 (175.0)
			00M	4.4 (7.5)	8.8 (15.0)	14 (23.8)	20 (34.0)	24 (40.8)	30 (51.0)	36 (61.2)	43 (73.1)	56 (95.1)	68 (115.5)	81 (137.6)	133 (226.0)
31S6, 33S6, 31G, 33G, 37/12	100-12	05M	5	2.4 (4.1)	5.2 (8.8)	8.0 (13.6)	11 (18.7)	14 (23.8)	17 (28.9)	21 (35.7)	24 (40.8)	32 (54.4)	39 (66.3)	47 (79.9)	76 (129.1)
			10	3.6 (6.1)	7.8 (13.3)	12 (20.4)	17 (28.9)	21 (35.7)	26 (44.2)	31 (52.7)	37 (62.9)	48 (81.6)	69 (117.2)	70 (118.9)	114 (193.7)
	100-25	05M	20	4.8 (8.2)	10 (17.0)	16 (27.2)	22 (37.4)	28 (47.6)	34 (57.8)	41 (70.0)	49 (83.3)	64 (108.7)	78 (132.5)	93 (158.3)	152 (258.2)
			40	7.2 (12.2)	16 (27.2)	24 (40.8)	33 (56.1)	42 (71.4)	51 (86.6)	62 (105.3)	73 (124.0)	95 (161.4)	118 (200.5)	140 (237.9)	229 (389.1)
			70	10 (17.0)	22 (37.4)	34 (57.8)	47 (79.9)	60 (101.9)	72 (122.3)	88 (4.1)	104 (176.7)	135 (229.4)	167 (283.7)	198 (336.4)	324 (550.0)
			00M	13 (22.1)	29 (49.3)	44 (74.8)	61 (103.6)	77 (30.8)	94 (159.7)	113 (192.0)	134 (227.7)	175 (297.3)	216 (367.0)	256 (434.9)	419 (711.9)
41S6, 45S6, 41G, 45G, 37/25	100-25	05M	5	3.4 (5.8)	7.2 (12.2)	11 (18.7)	16 (7.2)	20 (34.0)	24 (0.8)	29 (49.3)	34 (57.8)	45 (76.5)	55 (93.4)	66 (112.1)	108 (183.5)
			10	5.1 (8.7)	11 (17.7)	17 (28.9)	23 (9.1)	30 (51.0)	36 (61.2)	44 (74.8)	52 (88.3)	68 (115.5)	83 (141.0)	99 (168.2)	161 (273.5)
	100-25	05M	20	6.8 (11.6)	14 (23.8)	23 (39.1)	31 (2.7)	40 (68.0)	48 (81.6)	58 (98.5)	69 (117.2)	90 (152.9)	111 (188.6)	132 (224.3)	215 (365.3)
			40	10 (17.0)	22 (37.4)	34 (57.8)	47 (9.9)	59 (100.2)	72 (122.3)	88 (149.5)	103 (175.0)	135 (229.4)	166 (282.0)	197 (334.7)	323 (548.8)
			70	14 (23.8)	31 (52.7)	48 (81.6)	66 (12.1)	84 (142.7)	102 (173.3)	124 (210.7)	146 (248.1)	191 (324.5)	235 (399.3)	280 (475.7)	457 (776.4)
			00M	19 (32.3)	40 (68.0)	63 (107.0)	86 (46.1)	109 (185.2)	132 (224.3)	161 (237.5)	189 (321.1)	248 (421.4)	305 (518.2)	362 (615.0)	592 (1,005.8)

Specifications

Balston Sintered Metal Filter

Filter Efficiency	5 micron to 100 micron (nominal) in gas and liquid
Materials of Construction	316L Stainless Steel Cartridge, Viton Gasket
Maximum Temperature	400°F (204°C)
Maximum Pressure Drop	200 psid (14 bar)
Dimensions (including gaskets)	
050-11 size	.75"OD x 2.28"L
100-12 size	1.21"OD x 2.48"L
100-25 size	1.21"OD x 6.98"L
Shipping Weight	0.5 lb. (0.2 kg)

Ordering Information for assistance, call 800-343-4048. 8am to 5pm Eastern Time.

	050-11 Size	100-12 Size	100-25 Size
Sintered Metal Filter	050-11(-)	100-12(-)	100-25(-)
Replacement Viton Gaskets	A05-0045	A05-0046	A05-0046
Example: 100-12-40M			

Sintered Stainless Steel Cartridges

Filter Housing Model	Filter Size	Filter Cartridge Grade	Water Flow Rate in GPH at 1 PSI pressure drop
95, 85, 91	050-11	05M	11
		10M	26
		20M	30
		40M	35
		70M	38
		00M	38
31S6, 33S6, 31G, 33G, 37/12	100-12	05M	26
		10M	62
		20M	71
		40M	82
		70M	93
		00M	93
41S6, 45S6, 41G, 45G, 37/25	100-25	05M	61
		10M	111
		20M	128
		40M	148
		70M	154
		00M	154

Sample Filters

Chemical and Temperature Resistance Selection

Chemical and Temperature Resistance of Filter Cartridges (For Temperatures Up To 75°F/24°C)*

Chemical or Solvent	X-Type or Q-Type with Fluorocarbon Resin Binder	S-Type with PTFE Resin Binder	H-Type with Quartz Construction	LP Cartridge with Polypropylene Support
Maximum Operating Temperature	300°F (150°C)	500°F (260°C)	1000°F (538°C)	180°F (82°C)
Cold Water	Excellent	Excellent	Fair	Excellent
Hot Water (to 180°F/82°C)	Excellent	Excellent	Not Recommended	Excellent
Steam (to 20 psig/1.4 barg)	Excellent	Excellent	Not Recommended	Not Recommended
Acids, except Hydrofluoric:				
Dilute concentrations	Excellent	Excellent	Excellent	Excellent
Intermediate concentrations	Excellent	Excellent	Excellent	Good
Concentrated, except phosphoric	Good-Fair	Good-Fair	Excellent	Not Recommended
Concentrated phosphoric acid	Not Recommended	Not Recommended	Not Recommended	Not Recommended
Hydrofluoric Acid	Not Recommended	Not Recommended	Not Recommended	Not Recommended
Caustic, below 45%	Excellent	Excellent	Not Recommended	Fair
Caustic, above 45%	Fair	Fair	Not Recommended	Not Recommended
Chlorine, liquid or gas	Excellent	Excellent	Excellent	Not Recommended
Ammonia, liquid or gas	Not Recommended	Good-Fair	Not Recommended	Fair
Ethylene Oxide, liquid or gas	Not Recommended	Not Recommended	Not Recommended	See Pack 5
Aromatic Hydrocarbons	Excellent	Excellent	Excellent	Good
All other Hydrocarbons	Excellent	Excellent	Excellent	Excellent
Hydrogen Sulfide:				
Wet				
Dry				
Ketones	Not Recommended	Excellent	Excellent	Fair
Alcohols	Excellent	Excellent	Excellent	Excellent
Freons	Excellent	Excellent	Excellent	Not Recommended
Phenol	Excellent	Excellent	Excellent	Not Recommended
Chlorinated Solvents	Excellent	Excellent	Excellent	Fair
Oxygen	Not Recommended	Not Recommended	Excellent	Not Recommended
Ethylene Diamine	Excellent	Excellent	Excellent	Not Recommended
Ethanolamine	Not Recommended	Excellent	Excellent	Not Recommended
Other Amines	Good-Fair	Good-Fair	Excellent	Not Recommended
Polar Solvents, including: DMF, DMAC, NMP, DMSO	Not Recommended	Not Recommended	Excellent	Not Recommended

*Consult factory for compatibility at elevated temperatures

Application Index

Operating Requirement	Filter Cartridge Type	Stainless Steel, Monel, or Aluminum Housing	Plastic Housing
Severe Operating Conditions			
Pressure 250 to 5000 psig (17.2 to 345 barg)	All	91S6, 97S6, 95M, 85, 37/12, 37/25, 27/35, 27/80, 95S6, 95A, 48S6, 49S6, 105S6, 47S6	N/A
Temperature 300°F (150°C) to 600°F (315°C)	H, M	Any stainless steel or Monel housing with Viton seals	N/A
Temperature 600°F (315°C) to 900°F (480°C)	H, M	30/12, 30/25	N/A
Exceptional Chemical Resistance	See chart above	95M/Monel	9922□-□, 8822□-□/PVDF, 95T/PTFE 90/Polypropylene
NACE Compliance	All	95S6, 85, 37/12, 37/25, 27/35, 27/80	NA
Functional Requirements			
Separate liquids from gases	X, Q, S	All housings except 97S6, 30/12, 30/25, 48S6, 49S6, 47S6	8822-11, 8833-11, 95T
Separate two liquid phases	X, LP, S	All housings except 97S6, 30/12, 30/25, 48S6, 49S6, 47S6	8822-11, 8833-11, 95T
Remove gas bubbles from liquids	X, Q, S	All housings except 97S6, 30/12, 30/25, 48S6, 49S6, 47S6	8822-11, 95T
Quantitative measurement of solids in gases	H, Q, S	30/12, 30/25	N/A
Slipstream or Bypass Filtration	X, Q, LP, M, S	All housings except 97S6, 30/12, 30/25	8822-11, 95T, 53/18, 53/50
Filter liquids with high solids content	LP, M	All housings	All housings
Filter gas or liquid samples to analyzers	X, Q, LP, M, S	All housings	9933-05, 9922-05, 90

Sample Filters

Filter Cartridge, Housing Selection/Flow Rates for Liquid Filters

Flow Rates For Liquid Filters			Water Flow Rate, Gallons Per Hour						
Filter Housing Model	Volume of Housing Gallons	Liters	Initial Pressure Drop	Q or X Cartridges		LP Cartridges			
				DQ, DX	BQ, BX	Grade 10	Grade 20	Grade 30	Grade 50
Stainless Steel, Monel and PTFE Housings									
105S6			1 psi (0.07 bar)	7 (0.44)	2 (0.13)	---	---	---	---
			5 psi (0.34 bar)	24 (1.51)	10 (0.63)	---	---	---	---
48S6			1 psi (0.07 bar)	14 (0.88)	4 (0.25)	---	---	---	---
			5 psi (0.34 bar)	51 (3.22)	21 (1.32)	---	---	---	---
95M, 95S6, 95T, 95A 91S6, 47S6 85	0.005 .009 0.015	0.02 0.036 0.06	1 psi (0.07 bar)	18 (1.14)	5 (0.32)	---	---	---	---
			5 psi (0.34 bar)	64 (4.04)	26 (1.64)	---	---	---	---
31S6	0.026	0.098	1 psi (0.07 bar)	54 (3.41)	13 (0.82)	---	---	---	---
31G			5 psi (0.34 bar)	129 (8.14)	56 (3.53)	---	---	---	---
49S6			1 psi (0.07 bar)	57 (3.60)	14 (0.88)	---	---	---	---
			5 psi (0.34 bar)	135 (8.52)	60 (3.79)	---	---	---	---
33S6 33G 37/12	0.042	0.16	1 psi (0.07 bar)	63 (3.97)	16 (1.01)	50 (3.15)	50 (3.15)	40 (2.52)	10 (0.63)
			5 psi (0.34 bar)	150 (9.46)	66 (4.16)	210 (13.25)	210 (13.25)	180 (11.36)	45 (2.84)
41S6	0.051	0.19	1 psi (0.07 bar)	95 (5.99)	30 (1.89)	---	---	---	---
41G			5 psi (0.34 bar)	260 (16.40)	121 (7.63)	---	---	---	---
37/25 45S6 45G	0.111	0.42	1 psi (0.07 bar)	109 (6.88)	35 (2.21)	75 (4.73)	75 (4.73)	60 (3.79)	15 (0.95)
			5 psi (0.34 bar)	300 (18.93)	140 (8.83)	300 (18.93)	300 (18.93)	260 (16.40)	65 (4.10)
27/35	0.394	1.49	1 psi (0.07 bar)	325 (20.50)	90 (5.68)	---	---	---	---
			5 psi (0.34 bar)	875 (55.20)	400 (25.24)	---	---	---	---
27/80	0.750	2.84	1 psi (0.07 bar)	390 (24.61)	170 (10.73)	---	---	---	---
			5 psi (0.34 bar)	990 (62.46)	610 (38.49)	---	---	---	---
15/80S6 (2)			1 psi (0.07 bar)	1650 (104.10)	720 (45.42)	---	---	---	---
			5 psi (0.34 bar)	4000 (252.36)	2500 (157.73)	---	---	---	---
Plastic Housings									
9922-05	0.003	0.01	1 psi (0.07 bar)	12 (0.76)	3 (0.19)	---	---	---	---
9933-05			5 psi (0.34 bar)	30 (1.89)	15 (0.95)	---	---	---	---
8822-11, 8833-11	0.005	0.02	1 psi (0.07 bar)	18 (1.14)	5 (0.32)	---	---	---	---
9922-11, 9933-11			5 psi (0.34 bar)	45 (2.84)	26 (1.64)	---	---	---	---
8800-12			1 psi (0.07 bar)	54 (1.14)	13 (0.32)	---	---	---	---
			5 psi (0.34 bar)	129 (2.84)	56 (1.64)	---	---	---	---
90			1 psi (0.07 bar)	23 (1.45)	10 (0.63)	---	---	---	---
			5 psi (0.34 bar)	46 (.90)	36 (2.27)	---	---	---	---
58P	0.034	0.13	1 psi (0.07 bar)	---	---	50 (3.15)	50 (3.15)	40 (2.52)	10 (0.63)
			5 psi (0.34 bar)	---	---	210 (13.25)	210 (13.25)	180 (11.36)	45 (2.84)
53/18	0.185	0.70	1 psi (0.07 bar)	---	---	100 (6.31)	100 (6.31)	100 (6.31)	40 (2.52)
			5 psi (0.34 bar)	---	---	360 (22.71)	360 (22.71)	360 (22.71)	190 (11.99)
53/50	0.346	1.31	1 psi (0.07 bar)	---	---	210 (6.31)	210 (6.31)	210 (6.31)	80 (2.52)
54/50			5 psi (0.34 bar)	---	---	720 (22.71)	720 (22.71)	720 (22.71)	390 (11.99)
53/95	0.661	2.50	1 psi (0.07 bar)	---	---	420 (26.50)	420 (26.50)	420 (26.50)	160 (10.09)
			5 psi (0.34 bar)	---	---	1440 (90.85)	1440 (90.85)	1440 (90.85)	780 (49.21)

Notes: 1 For liquids with viscosity higher than the viscosity of water (1 centipoise), divide the flow rates in the above table by the viscosity of the liquid in centipoises.
 Example: For liquid with 10 centipoise viscosity, flow rate with Model 53/50 housing, Grade 50 filter cartridges at 5 psi (0.34 bar) drop will be 390/10=39 GPH (2.5 lpm).
 2 Flow rates for Model 15/80S6 are estimated.

Metric Flow Rates for Air and Gas Filters

Filter Housing Model	Volume of Housing (ml)	Filter Tube Grade	Flow Rate (M ³ /hr) at 26 cm Water Press. Drop.																							
			(1) Flow Rates, Nm ³ /hr, at 0.14 BAR Drop at Indicated Line Pressure, BARG																							
			Refer to Product Specification Charts for Maximum Pressure Rating of Each Housing																							
			0.14	1.14	3	4	6	7	9	10	14	17	21	35	52	69	103	138	172	207	241	276	310	345		
			bar	bar	bar	bar	bar	bar	bar	bar	bar	bar	bar	bar	bar	bar	bar	bar	bar	bar	bar	bar	bar	bar	bar	
9922-05	11.33	DQ	2.039	4.248	6.626	9.175	11.55	14.1	17.16	---	---	---	---	---	---	---	---	---	---	---	---	---	---	---	---	
4433-05		BQ	1.359	2.718	4.417	5.947	7.646	9.175	11.21	---	---	---	---	---	---	---	---	---	---	---	---	---	---	---	---	
9900-05		DAU	0.85	2.039	---	4.417	5.607	6.796	---	---	---	---	---	---	---	---	---	---	---	---	---	---	---	---	---	---
9933-05		DAU	N/A	---	---	---	---	---	---	---	---	---	---	---	---	---	---	---	---	---	---	---	---	---	---	---
8833-11	19.82	DX	3.058	6.116	10.19	13.59	16.99	20.39	24.81	---	---	---	---	---	---	---	---	---	---	---	---	---	---	---	---	
9922-11		BX	1.529	3.058	5.097	6.796	8.495	10.19	12.4	---	---	---	---	---	---	---	---	---	---	---	---	---	---	---	---	
9933-11	16	DAU	1.189	2.888	16.99	6.286	7.306	8.495	45.87	54.37	69.66	88.35	101.9	168.2	249.8	331.3	492.7	655.8	818.9	982	1145	1308	1505	1634		
105S6		DAU	N/A	---	---	---	---	---	---	---	---	---	---	---	---	---	---	---	---	---	---	---	---	---	---	---
97S6	11.33	DQ	1.1893	11.89	16.99	23.79	30.58	37.38	45.87	54.37	69.66	86.65	101.9	168.2	249.8	331.3	492.7	655.8	818.9	982	1145	1308	1505	1634		
95A, 95M, 95S6, 95T, 91S6, 47S6	19.82	BQ	1.529	3.058	5.097	6.796	8.495	10.19	11.89	15.29	18.69	23.79	27.18	44.17	66.26	88.35	130.8	175	217.5	261.6	304.1	348.3	390.8	434.9		
		DQ	6.626	13.59	22.09	30.58	37.38	45.87	56.07	66.26	86.65	105.3	125.7	205.6	305.8	406.1	606.5	798.5	1002	1206	1597	1901	2005			
48S6	21	DQ	4.248	16.99	27.18	39.08	47.57	56.07	67.96	79.85	103.6	127.4	151.2	246.4	356.8	475.7	713.6	951.4	1189	1427	1665	1903	2141	2379		
		BQ	3.398	8.495	13.59	15.29	16.99	18.69	22.09	27.18	33.98	42.48	49.27	78.15	118.9	152.9	220.9	305.8	373.8	441.7	509.7	577.7	645.6	713.6		
85	59.47	DX	10.02	20.39	33.13	44.17	54.37	69.66	84.95	98.54	129.1	156.3	188.6	309.2	458.7	611.6	917.5	1206	1512	1809	2115	2413	2718	3007		
		BX	3.738	7.815	13.08	16.99	20.39	25.49	30.58	37.38	47.57	57.77	69.66	115.5	192	227.7	339.8	450.2	552.2	679.6	807	900.5	1002	1121		
90	23.3	DQ, DX	---	---	---	---	---	---	---	---	---	---	---	---	---	---	---	---	---	---	---	---	---	---	---	
		BQ, BX	0.8495	---	---	---	---	---	---	---	---	---	---	---	---	---	---	---	---	---	---	---	---	---	---	
8800-12 (2)	93.45	DQ, DX	16.99	37.38	59.47	81.55	103.6	125.7	152.9	181.8	237.9	292.2	348.3	---	---	---	---	---	---	---	---	---	---	---	---	
		BQ, BX, DAU	3.398	10.19	15.29	20.39	27.18	33.98	40.78	49.27	62.86	78.15	91.75	---	---	---	---	---	---	---	---	---	---	---	---	
30/12, 33S6, 33G, 37/12	158.58	DX	5.097	20.39	44.17	67.96	93.45	118.9	144.4	175	207.3	333	395.9	647.3	963.3	1278	1906	2537	3165	3796	4417	5046	577.7	645.6		
		BX	0.8495	5.097	11.89	16.99	23.79	30.58	37.38	45.87	54.37	69.66	86.65	101.9	168.2	249.8	331.3	494.4	657.5	820.6	983.7	1181	1308	---	---	
49S6	170	DQ	22.09	47.57	76.46	103.6	132.5	159.7	195.4	229.4	300.7	370.4	440	718.7	1069	1417	2115	---	---	---	---	---	---	---	---	
		BQ	10.19	22.09	35.68	47.57	59.47	73.06	90.05	105.3	137.6	169.9	202.2	329.6	489.3	650.7	970.1	---	---	---	---	---	---	---	---	
41S6, 41G	220.87	DQ, DX	54.37	84.95	117.2	147.8	180.1	219.2	258.2	338.1	416.3	494.4	---	---	---	---	---	---	---	---	---	---	---	---	---	
		BQ, DX	1.8689	25.49	40.78	54.37	69.66	84.95	103.6	122.3	158	195.4	236.2	---	---	---	---	---	---	---	---	---	---	---	---	
30Z5, 45S6, 45G, 37Z5	419.09	DQ, DX	28.88	61.16	96.84	132.5	168.2	203.9	248.1	292.2	382.3	470.6	559	914.1	1359	1804	2693	3581	4470	5362	6252	7136	---	---		
		BQ, BX	2.2087	13.59	28.88	44.17	61.16	76.46	93.45	113.8	134.2	175	215.8	256.5	419.7	623.5	827.4	1235	1658	2051	2458	2871	3279	---	---	
27S5	1500.80	DX	22.5967	67.96	141	220.9	302.4	382.3	463.8	564.1	666	866.5	1069	1271	2073	3092	4095	6116	8121	10143	12165	14170	16191	202180		
26S5	2860.02	BX	5.6067	32.28	66.26	105.3	142.7	181.8	219.2	266.7	314.3	409.5	504.6	599.7	982	1458	1937	2888	3840	4791	5743	6694	7646	9565		
27R0	4700	DX	33.98	152.9	241.3	236.2	416.3	504.6	615	723.8	942.9	1164	1383	2260	3364	4460	6626	---	---	---	---	---	---	---	---	
		BX	9.8542	47.57	100.2	158	215.8	273.5	331.3	402.7	475.7	620.1	762.9	907.3	1483	2209	2926	4315	---	---	---	---	---	---	---	
15/80S6	4700	DX	33.98	271.8	565.8	892	1218	1543	1869	2277	2684	3500	4315	5131	8393	---	---	---	---	---	---	---	---	---	---	
		BX	9.8542	76.46	159.7	251.5	343.2	434.9	526.7	642.2	756.1	985.4	1215	1444	2362	---	---	---	---	---	---	---	---	---	---	

NA = DATA NOT AVAILABLE
 1 For line pressures above 150 PSIG, flow rate values are estimated.
 2 Maximum operating pressure in gas service is 50 PSIG.



Sample Filter Quick Select Guide

Sample Filters

	Part Number	Description	Inlet/Outlet Port	Drain (or bypass) Port
T-Style Sample Filters	105S6	T-Type Filter - Small Volume Bypass/Slipstream	1/8" NPT	1/8" NPT
	91S6 ¹	T-Type Filter - Low Volume Bypass/Slipstream	1/8" NPT	1/8" NPT
	95A ¹	T-Type Filter - Std. Volume Bypass/Slipstream	1/8" NPT	1/8" NPT
	95M ¹	T-Type Filter - Std. Volume Bypass/Slipstream	1/8" NPT	1/8" NPT
	95S6 ¹	T-Type Filter - Std. Volume Bypass/Slipstream	1/8" NPT	1/8" NPT
	95T ¹	T-Type Filter - Std. Volume Bypass/Slipstream	1/8" NPT	1/8" NPT
	85	T-Type - High Press. - Low Flow Bypass/Slipstream	1/4" NPT	1/4" NPT
	37/12	T-Type Filter - High Pressure - Standard Flow	1/2" NPT	1/8" NPT
	37/25	T-Type Filter - High Pressure - Standard Flow	1/2" NPT	1/8" NPT
	33G	T-Type Filter - High Volume	1/2" NPT	1/8" NPT
45G	T-Type Filter - High Volume	1/2" NPT	1/8" NPT	
33S6	T-Type Filter - High Volume	1/2" NPT	1/8" NPT	
45S6	T-Type Filter - High Volume	1/2" NPT	1/8" NPT	
31G	T-Type Filter - Low Volume	1/2" NPT	1/4" NPT	
31G-1/4	T-Type Filter - Low Volume	1/4" NPT	1/4" NPT	
41G	T-Type Filter - Low Volume	1/2" NPT	1/4" NPT	
41G-1/4	T-Type Filter - Low Volume	1/4" NPT	1/4" NPT	
31S6	T-Type Filter - Low Volume	1/2" NPT	1/4" NPT	
31S6-1/4	T-Type Filter - Low Volume	1/4" NPT	1/4" NPT	
41S6	T-Type Filter - Low Volume	1/2" NPT	1/4" NPT	
41S6-1/4	T-Type Filter - Low Volume	1/4" NPT	1/4" NPT	
27/35	T-Type Filter - Moderate Pressure - High Flow	1" NPT	1/4" NPT	
27/35-3000	T-Type Filter - High Pressure - High Flow	1" NPT	1/4" NPT	
27/80	T-Type Filter - Moderate Pressure - High Flow	1" NPT	1/4" NPT	
27/80-3000	T-Type Filter - High Pressure - High Flow	1" NPT	1/4" NPT	
26/35D-3000	T-Type Filter - High Pressure - High Flow	1" NPT	1/4" NPT	
26/35D-5000	T-Type Filter - High Pressure - High Flow	1" NPT	1/4" NPT	
15/80S6	T-Type Filter - Moderate Pressure - High Flow	2" NPT	1/4" NPT	

Note¹: Also available in 1/4" NPT Inlet Outlet by adding "-1/4" suffix to part number.

A: Coalescing:

If the unit is used in the traditional in/out flow path with a drain connected the filter will function as a coalescing filter provided a "_X" type of element is used.

B: Particulate:

For particulate only removal the filter may be used in either flow direction and a "_Q", "_S", or "_H" type of element is used.

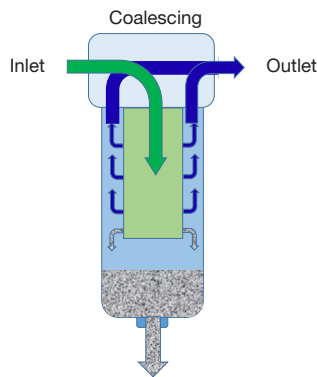

C: Slipstream or Bypass

Sampling:

In this flow configuration the filter will allow a sample to be pulled from a flowing gas stream. This configuration only provides particulate filtration. A coalescing filter can be added after this to provide liquid aerosol removal.

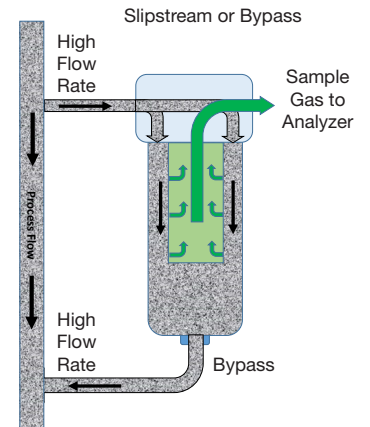

Sample Filter Quick Select Guide

Flow Diagram	Flow @ 100 PSIG w/ "B" Element	Flow @ 1000 PSIG w/ "B" Element	Max Pressure	Max Temp Degrees F	Housing/ Bowl Material	Part Number
B, C, D	5	195	5000	400°	316 SS	105S
B, C, D	10	88	1500	400°	316 SS	91S6
B, C, D	10	88	2500	200°	Aluminum	95A
B, C, D	10	88	5000	400°	Monel	95M
B, C, D	10	88	5000	400°	316 SS	95S6
B, C, D	10		150	300°	PTFE	95T
A, B, C, D	15	134	5000	400°	316 SS	85
A, B, C, D	22	195	4000	400°	316 SS	37/12
A, B, C, D	55	487	4000	400°	316 SS	37/25
A, B, C, D	22		100	160°	316 SS/Pyrex	33G
A, B, C, D	55		100	160°	316 SS/Pyrex	45G
A, B, C, D	22		425	400°	316 SS	33S6
A, B, C, D	55		250	400°	316 SS	45S
A, B, C, D	20		100	160°	316 SS/Pyrex	31G
A, B, C, D	20		100	160°	316 SS/Pyrex	31G-1/4
A, B, C, D	50		100	160°	316 SS/Pyrex	41G
A, B, C, D	50		100	160°	316 SS/Pyrex	41G-1/4
A, B, C, D	20		425	400°	316 SS	31S6
A, B, C, D	20		425	400°	316 SS	31S6-1/4
A, B, C, D	50		425	400°	316 SS	41S6
A, B, C, D	50		425	400°	316 SS	41S6-1/4
A, B, C, D	129		800	400°	316 SS	27/35
A, B, C, D	129	1140	3000	400°	316 SS	27/35-3000
A, B, C, D	195		800	400°	316 SS	27/80
A, B, C, D	195	1722	3000	400°	316 SS	27/80-3000
A, B, C, D	129	1140	3000	250°	Carbon Steel	26/35D-3000
A, B, C, D	129	1140	5000	250°	Carbon Steel	26/35D-5000
A, B, C, D	310		800	400°	Stainless Steel	15/80S6

Sample Filters

D: Slipstream + Coalescing Sampling:

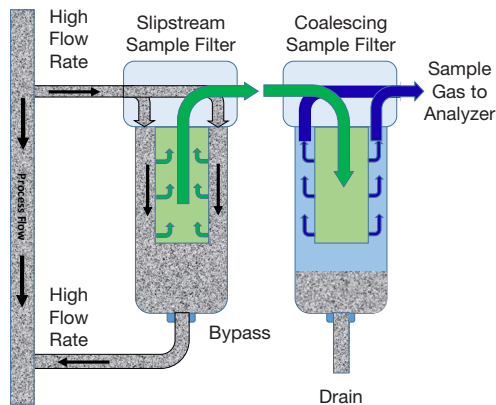

If the units are installed as shown in this diagram the first stage will remove bulk particulates from the sample stream and the second stage will remove liquid aerosols.

This application uses the same filter housing in series (plumbed differently) to provide a particulate and aerosol free sample to the analyzer.



Sample Filter Quick Select Guide

Sample Filters

		Part Number	Description	Inlet/Outlet Port	Drain (or bypass) Port
Fast Loop Sample Filters		31S6CFL-1/4	T-Type High Flow/Fast Loop	1/4" NPT	1/4" NPT
		41S6CFL-1/4	T-Type High Flow/Fast Loop	1/4" NPT	1/4" NPT
		31GCFL-1/4	T-Type High Flow/Fast Loop	1/4" NPT	1/4" NPT
		41GCFL-1/4	T-Type High Flow/Fast Loop	1/4" NPT	1/4" NPT
		48S6	Fast Loop Inline	1/4" NPT	1/4" NPT
		49S6	Fast Loop Inline	1/2" NPT	1/4" NPT
In-Line Sample Filters		97S6	In-Line Filter - Particulate	1/4" NPT	N/A
		30/12	In-Line Filter - Solids Capturing	1/2" NPT	N/A
		30/25	In-Line Filter - Solids Capturing	1/2" NPT	N/A

E: "T" Style Fast Loop Sampling:

Fast Loop Sampling allows a sample to be quickly drawn from the process stream with minimal lag time.

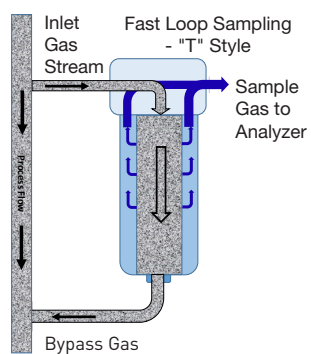

The "T" style filters have larger reservoirs plus the added benefit of see-thru bowls with the "G" option.

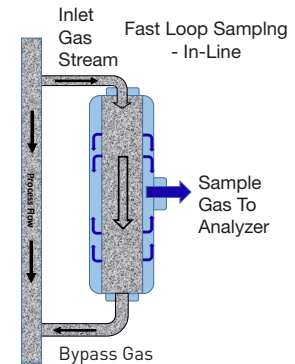

F: In-Line Sample Filtering:

In-line fast loop filters provide an economical way to draw a sample quickly from the process stream.



Membrane		98-0	Membrane Filter	1/4" NPT	1/4" NPT
		98-2	Membrane Filter	1/4" NPT	1/4" NPT
		39-0	Membrane Filter	1/2" NPT	1/4" NPT
		39-2	Membrane Filter	1/2" NPT	1/4" NPT
		A98/11- _Q-0	Coalescing Membrane Combination Filter	1/4" NPT	1/4" NPT
		A98/11- _Q-2	Coalescing Membrane Combination Filter	1/4" NPT	1/4" NPT
		A39/12- _X-0	Coalescing Membrane Combination Filter	1/2" NPT	1/4" NPT
		A39/12- _X-2	Coalescing Membrane Combination Filter	1/2" NPT	1/4" NPT
		A39/12G- _X-0	Coalescing Membrane Combination Filter	1/2" NPT	1/4" NPT
		A39/12G- _X-2	Coalescing Membrane Combination Filter	1/2" NPT	1/4" NPT

J: Hydrophobic Membrane Sample Filter:

Membrane sample filters use a hydrophobic membrane to filter any trace amounts of liquids from the sample stream before the analyzer. If the gas stream has higher levels of contamination consider using a membrane filter with an integral coalescing element (see K).

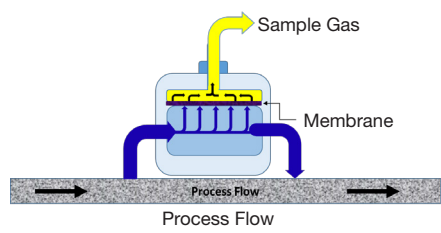

Specialty		38/12	Diesel Exhaust Analyzer Filter	1/4" NPT	N/A
		38/25	Diesel Exhaust Analyzer Filter	1/4" NPT	N/A
		47S6	In-Line Filter - Particulate - Horizontal Mount	1/4" NPT	N/A

Sample Filter Quick Select Guide

Flow Diagram	Flow @ 100 PSIG w/ "B" Element	Flow @ 1000 PSIG w/ "B" Element	Max Pressure	Max Temp Degrees F	Housing/ Bowl Material	Part Number
E	20		425	400°	316 SS	31S6CFL-1/4
E	50		250	400°	316 SS	41S6CFL-1/4
E	20		100	160°	316 SS/Pyrex	31GCFL-1/4
E	50		100	160°	316 SS/Pyrex	41GCFL-1/4
E	11	90	5000	400°	316 SS	48S6
E	43	383	1500	400°	316 SS	49S6
F	6	52	5000	400°	316 SS	97S6
H	22		100	600°	304 & 303 SS	30/12
H	55		100	600°	304 & 303 SS	30/25

Sample Filters

H: In-Line Solids Capturing:

The Model 30 In-Line Filters are designed to capture particulates for measurement. The removable end cap in the elements retains the solids for measurement.

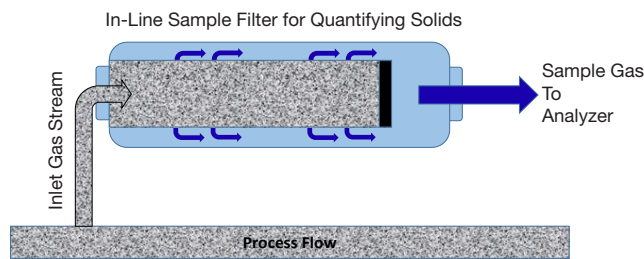

J	See Catalog		1000	200°	316 SS	98-0
J	See Catalog		1000	200°	316 SS	98-2
J	See Catalog		500	200°	316 SS	39-0
J	See Catalog		500	200°	316 SS	39-2
A + K	See Catalog		1000	200°	316 SS	A98/11-Q-0
A + K	See Catalog		1000	200°	316 SS	A98/11-Q-2
A + K	See Catalog		425	200°	316 SS	A39/12-X-0
A + K	See Catalog		425	200°	316 SS	A39/12-X-2
A + K	See Catalog		100	200°	316 SS & Pyrex	A39/12G-X-0
A + K	See Catalog		100	200°	316 SS & Pyrex	A39/12G-X-2

K: Hydrophobic Membrane Sample Filter + Coalescing:

Fast Loop Sampling allows a sample to be quickly drawn from the process stream with minimal lag time.

The "T" style filters have larger reservoirs plus the added benefit of see-thru bowls with the "G" option.

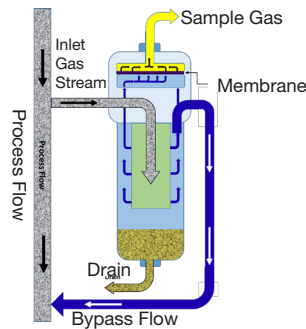

	See Catalog		20	450°	Stainless Steel	38/12
	See Catalog		20	450°	Stainless Steel	38/25
B	10	88	1500	400°	316 SS	47S6

Sample Filters

Miniature Disposable Filter Units Constructed of Nylon and PVDF

Prevent cross-contamination of samples

Pressure ratings up to 125 psig (8.62 barg)

Temperature to 275°F (135°C)

Completely disposable, constructed of recyclable plastics

Models 9922-05, 9933-05, 4433-05 and 9900-05

The 99XX-05 models are the smallest Disposable Filter Units with 11.7 ml internal volume. These models are used in low flow gas or liquid sampling applications, such as liquids to specific-ion analyzers or gases to personal samplers. The model 9900-05-BK has a color indicating feature, which turns the cartridge red when saturated with oil. The model 4433-05 has 1/4" and 3/8" Barb Connections molded into the inlet/outlet ports.

Models 9922-11, 9933-11, and 8800-12

Models 9922-11, 9933-11, and 8800-12 are used for applications similar to the smaller DFUs (Models 9922-05 and 9933-05) which require greater solids holding capacity and can tolerate the increased retention time.

Model 8833-11

These Disposable Filter Units are used as continuous coalescing filters with a third port serving as the drain, slip-stream, or by-pass port.

Parker Hannifin offers a manual drain valve for removal of coalesced liquids from the Type 8833-11-DX.

Drain Valve: 1/8" NPT (male) x 1/8" ID Tubing.

(Requires fitting part No. 11977). Part No. 20120.

Model 9953-11

This model snaps together for easy filter cartridge changeouts. It is designed primarily for low pressure or mild vacuum applications. It is ideal for capturing samples and perform analysis or record weights over time. If used with a X-tube, it is a very effective silencer to compress inlet noise to small pumps.

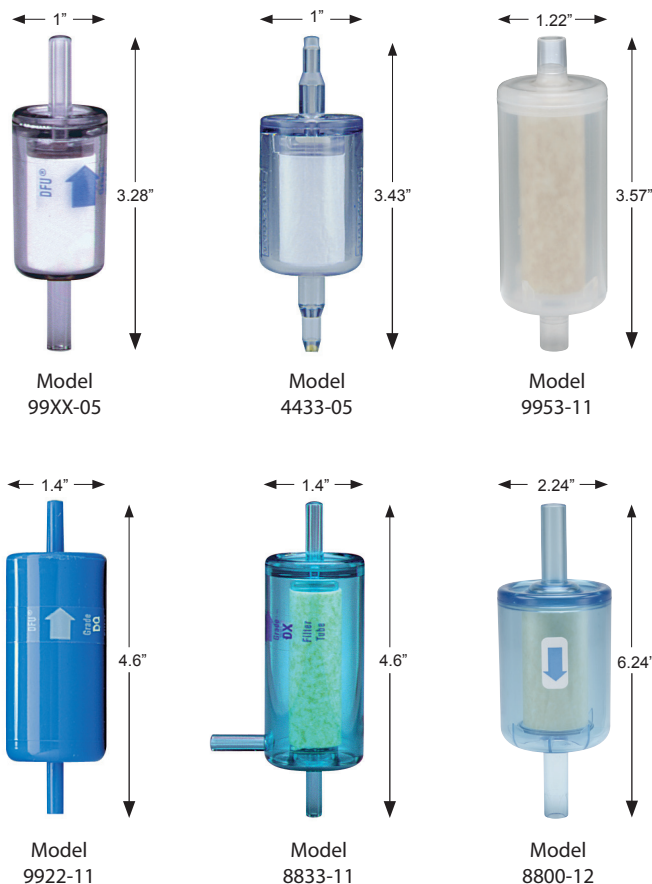

Chemical Compatibility Models 9922-05, 9922-11

Suitable: Water or steam to 200°F (135°C); concentrated nitric, sulfuric, and hydrochloric acids; chlorine (gas or liquid); sodium hypochlorite, ethylene oxide (gas or liquid); Freons; ammonia (gas, liquid, or aqueous solutions); hydrogen peroxide (all concentrations); bromine (dry and aqueous solutions); all chlorinated solvents except methylene chloride; all aromatic and aliphatic solvents; all alcohols and glycols; aniline; phenol.

Limited Use: Acetone, MEK, dioxane, furfural, methylene chloride.

Unsuitable: Water above 200°F (135°C), THF, DMF, ethylene diamine, chlorosulfonic acid, ethanolamine, pyridine, sulfur trioxide.

Chemical Compatibility Model 9933-11, 8833-11, and 8800-12

Suitable: Water to 158°F (70°C); benzene, toluene, other aromatic hydrocarbons; hydrocarbon solvents and fuels, perchloroethylene; trichloroethylene, nitric acid (to 10%); sulfuric acid (to 40%); hydrochloric acid (to 10%); most salt solutions; sodium and potassium hydroxide (to 50%).

Limited Use: Water at 158°F (70°C); acetone; MEK, acetaldehyde; ammonia (to 25%).

Unsuitable: Water above 176°F (80°C); alcohols; glycols, phenol; aniline; DMF; concentrated acids; chlorine.

Sample Filters

Miniature Disposable Filter Units Constructed of Nylon and PVDF

Flow Rates Water Flow Rate, Gallons per Hour

DFU Model	Volume of Housing Gallons	Liters	Initial Pressure Drop	Grade DQ, DX	Grade CQ, CX	Grade BQ, BX	Grade AQ	Grade AAQ
9922-05 4433-05 9933-05	0.003	0.01	1 psi (0.07 bar)	12 (0.76)	10 (0.63)	3 (0.19)	1.5 (0.09)	0.4 (0.03)
5 psi (0.34 bar)			30 (1.90)	25 (1.58)	15 (0.95)	7.3 (0.46)	1.9 (0.12)	
9922-11 9933-11			0.0005	0.02	1 psi (0.07 bar)	18 (1.14)	15 (0.95)	5 (0.34)
5 psi (0.34 bar)	45 (2.84)	37 (2.33)			26 (1.64)	12 (0.76)	3.1 (0.20)	
8800-12	.003	.014	1 psi (0.07 bar)	54 (3.74)	44 (3.03)	13 (0.90)	6 (0.41)	1.4 (0.10)
			5 psi (0.34 bar)	129 (8.89)	106 (7.31)	56 (3.86)	26 (1.79)	6.5 (0.45)

Sample
Filters

Principal Specifications

Model	9922-05	9900-05	4433-05	9933-05	9922-11	9933-11	8833-11	8800-12	9953-11
Inlet and Outlet Ports	1/4" Tubing	1/4" Tubing	1st Tier/Barb 1/4" Tube 2nd Tier/Barb 3/8" Tube	1/4" Tubing	1/4" Tubing	1/4" Tubing	1/4" Tubing	1/2" Tubing	0.32" OD
Drain	None	None	None	None	None	None	1/4" Tubing	None	None
Material of Construction	PVDF	Nylon	Nylon	Nylon	PVDF	Nylon	Nylon	Nylon	Polypropylene
Filter Cartridge Length	1.25" (3.2 cm)	1.25" (3.2 cm)	1.25" (3.2 cm)	1.25" (3.2 cm)	2.25" (5.7 cm)	2.25" (5.7 cm)	2.25" (5.7 cm)	2.5" (5.71 cm)	2.28" 6.35 cm
Maximum Temperature	275°F (135°C)(1)	230°F (110°C)(1)	230°F (110°C)(1)	230°F (110°C)(1)	275°F (135°C)(1)	230°F (110°C)(1)	230°F (110°C)(1)	150°F (66°C)(1)	125°F (52°C)(1)
Maximum Pressure	125 psig (8.6 barg) (2)	125 psig (8.6 barg) (2)	125 psig (8.6 barg) (2)	125 psig (8.6 barg) (2)	125 psig (8.6 barg) (2)	125 psig (8.6 barg) (2)	125 psig (8.6 barg) (2)	50 psig (3.03 barg) (2) (8)	2 psig (0.14 barg) (2)
Dimensions	1.0"D x 3.25"L (2.5 cm x 8 cm)	1.0"D x 3.25"L (2.5 cm x 8 cm)	1.0"D x 3.43"L (2.5 cm x 8.72 cm)	1.0"D x 3.25"L (2.5 cm x 8 cm)	1.4"D x 4.6"L (3.6 cm x 12 cm)	1.4"D x 4.6"L (3.6 cm x 12 cm)	1.4"D x 4.6"L (3.6 cm x 12 cm)	2.24"D x 6.24"L (5.69 cm x 15.85 cm)	1.22"D x 3.57"L (3.1 cm x 9.07 cm)

Notes:

1 At 0 psig
2 At 110°F (43°C)

3 To designate adsorbent in the DAU, insert adsorbent numbers after DAU designation. For example, to obtain a miniature clear nylon DAU

with carbon adsorbent, order 9933-05-000. Adsorbent numbers are listed on page 73.
4 Available only in Q grades.

5 Available in Q or X media.
6 Available only in X media.
7 9953-11 is designed for maximum pressure of 2 psig.

8 Pressure rating in liquid service is 70 PSIG (4.83 barg) maximum.

Sample Filters

Miniature Disposable Filter Units Constructed of Nylon and PVDF

Sample Filters

Ordering Information

For assistance, call toll-free at 1-800-343-4048 8AM to 5PM Eastern Time

Model	9922-05	9900-05	4433-05	9933-05	9922-11	9933-11	8833-11	8800-12	9953-11
Box of 10 DFUs Available only in Q-grades	9922-05-□	9900-05-□ (4)	4433-05-□ (4)	9933-05-□	9922-11-□	9933-11-□	8833-11-□ (6)	8800-12-□ box of 1	9953-11-□ (5)
Box 10 DAU'S (3)	9922-05-□	N/A	N/A	9933-05-□	9922-11-□	9933-11-□	N/A	N/A	N/A

Notes:

- | | | | | |
|-------------------|---|--|---|---|
| 1 At 0 psig | 3 To designate adsorbent in the DAU, insert adsorbent numbers after DAU designation. For example, to obtain a miniature clear nylon DAU | with carbon adsorbent, order 9933-05-000. Adsorbent numbers are listed on page 73. | 5 Available in Q or X media. | 8 Pressure rating in liquid service is 70 PSIG (4.83 barg) maximum. |
| 2 At 110°F (43°C) | | 4 Available only in Q grades. | 6 Available only in X media. | |
| | | | 7 9953-11 is designed for maximum pressure of 2 psig. | |

Installation Information

To pressure pipe or tubing: Compression fittings for 1/4" O.D. tubing may be obtained from the following manufacturers. Hoke, Inc. ("Gyrolok"); Crawford Fitting Co. ("Swagelok"); Parker-Hannifin Corp. ("CPI"); Legris, Inc. (push-on fittings); Jaco Mfg. Co. (plastic fittings). The following brass fittings which seal by O-ring compression and which may be completely recovered and reused when changing filters may be purchased from Parker/Balston:

To low pressure plastic tubing: Tubing with 1/4" ID may be slipped over the DFU and fittings and held with tubing clamps. Parker Hannifin supplies plastic barbs to connect the DFU to smaller diameter plastic tubing. The connection is suitable for pressures to 50 psig.

- | | |
|-------------------------|----------------------------------|
| DFU to 1/16" ID tubing: | Part No. 14000 (bag of 20 barbs) |
| DFU to 1/8" ID tubing: | Part No. 14001 (bag of 20 barbs) |

Connector: 1/4" tubing to 1/4" NPT female - Part No. 11970 (1 per pkg.)

Connector: 1/4" tubing to 1/4" tubing - Part No. 11971 (1 per pkg.)

Sample Filters

Balston OEM Disposable Filter Solutions



Balston Disposable Filter Units

Ideal for the following gas filtration applications:

- Final filter for air logic devices
- Protection of pneumatic components
- Filtration of portable environmental sampling devices
- Filtration of samples to on-line analyzers
- Protection of Pneumatic temperature controls

Ideal for the following liquid filtration applications:

- Filtration of liquid with minimum holdup volume
- Filtration of liquid samples to analyzers

Additional applications in the following industries:

- Instrument & Controls
- HVAC
- Dental
- Automotive
- Food Packaging

This section is designed to help customers choose the best Balston disposable filter product for industrial, commercial, measurement and control applications.

Balston brand disposable filter units (DFU) consist of a microfibre filter cartridge permanently bonded into a sealed plastic holder with 125 psig (8.62 barg) pressure ratings, temperatures to 275°F (135°C), and available in low and high flow models. The economical DFU offers all of the advantages of microfibre filter cartridges for high efficiency liquid and gas filtration, combined with the economics and convenience of complete disposability.

Our years of experience in fitting products to individual applications has led to the creation of a variety of standard products that can be ordered off the shelf for general purpose filtration requirements or can be custom designed for all types of specialty applications.

If you do not see the specific configuration, size or material that you are looking for, our OEM engineering team will be happy to review your requirements and design product to your exact specifications.

If you have questions, or would like to place an order, please call 1-800-343-4048.

Sample Filters

OEM Disposable Filter Solutions

General Purpose DFU - Low Flow Gas

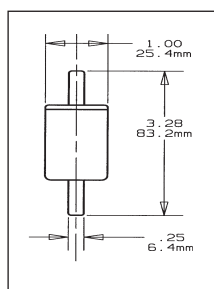

Model 9933-05

Specifications

Max. Pressure at 110°F (43°C):	125 psig (8.62 barg)
Max. Temp. at 0 psig:	230°F (110°C)
Inlet / Outlet Ports:	1/4" Tube
Drain:	None
Housing Material of Construction:	Nylon
Internal Volume:	.01L

Ordering Information

9933-05- Box of 10
Available in Type Q and in the following grades: A, B, C, BK, and D. Also available with adsorbents 000, 101, 103, and 107.

General Purpose DFU - Higher Flow

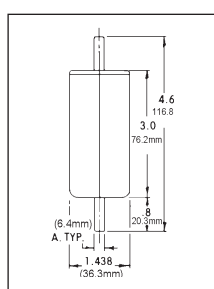

Model 9933-11

Specifications

Max. Pressure at 110°F (43°C):	125 psig (8.62 barg)
Max. Temp. at 0 psig:	230°F (110°C)
Inlet / Outlet Ports:	1/4" Tube
Drain:	None
Housing Material of Construction:	Nylon
Internal Volume:	.02L

Ordering Information

9933-11- Box of 10
Available in Type Q and in the following grades: A, B, C, and D. Also available with adsorbents 000, 101, 103, and 107.

General Purpose with Integral Barb Fittings

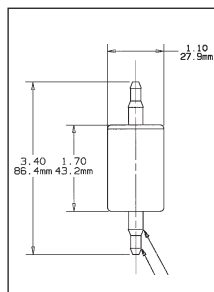

Model 4433-05

Specifications

Max. Pressure at 110°F (43°C):	125 psig (8.62 barg)
Max. Temp. at 0 psig:	230°F (110°C)
Inlet / Outlet Ports:	1st Tier: 1/4" Tube 2nd Tier: 3/8" Tube
Drain:	None
Material of Construction:	Nylon
Internal Volume:	.01L

Ordering Information

4433-05- Box of 10
Available in Type Q and in grades: A, B, C and D.

General Purpose with Drain Port

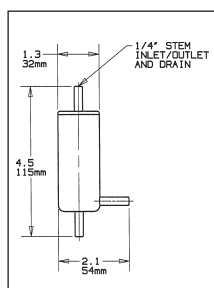

Model 8833-11

Specifications

Max. Pressure at 110°F (43°C):	125 psig (8.62 barg)
Max. Temp. at 0 psig:	230°F (110°C)
Inlet / Outlet Ports:	1/4" Tube
Drain:	1/4" Tube
Housing Material of Construction:	Nylon
Internal Volume:	.02L

Ordering Information

8833-11- Box of 10
Available in Types Q and X and in the following grades: A, B, C, D, and S.

Sample Filters

OEM Disposable Filter Solutions

High Chemical Resistance - Low Flow

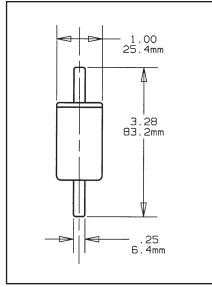

Model 9922-05

Specifications

Max. Pressure at 110°F (43°C): 125 psig (8.62 barg)
 Max. Temp. at 0 psig: 275°F (135°C)
 Inlet / Outlet Ports: 1/4" Tube
 Drain: None
 Housing Material of Construction: PVDF
 Internal Volume: .01L

Ordering Information

9922-05- Box of 10
 Available in Type Q and in the following grades: A, B, C, D. Also available with adsorbents 000, 101, 103, and 107.

High Chemical Resistance DFU -Higher Flow

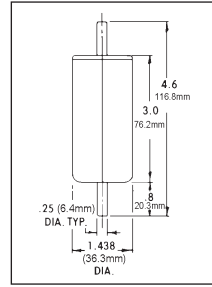

Model 9922-11

Specifications

Max. Pressure at 110°F (43°C): 125 psig (8.62 barg)
 Max. Temp. at 0 psig: 275°F (135°C)
 Inlet / Outlet Ports: 1/4" Tube
 Drain: None
 Housing Material of Construction: PVDF
 Internal Volume: .02L

Ordering Information

9922-11- Box of 10
 Available in Types Q and in the following grades: A, B, C, and D. Also available with adsorbents 000, 101, 103, and 107.

Oil Indicating DFU

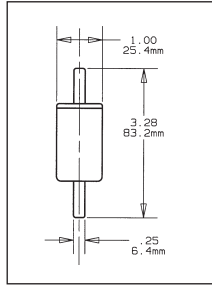

Model 9900-05

Specifications

Max. Pressure at 110°F (43°C): 125 psig (8.62 barg)
 Max. Temp. at 0 psig: 230°F (110°C)
 Inlet / Outlet Ports: 1/4" Tube
 Drain: None
 Housing Material of Construction: Nylon
 Internal Volume: .01L

Ordering Information

9900-05- Box of 10
 Available in Type K and in grade B.

Large Capacity High Flow DFU

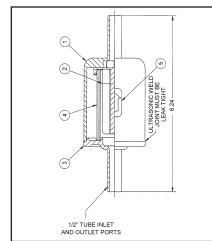

Model 8800-12

Specifications

Max. Pressure at 110°F (43°C): 50 psig (3.4 barg)
 Max. Temp. at 0 psig: 150°F
 Inlet / Outlet Ports: 1/2" Tube
 Drain: None
 Housing Material of Construction: Nylon
 Internal Volume: .0138L

Ordering Information

8800-12- Box of 1
 Available in Types Q and X and in the following grades: A, B, C, and D. Also available with adsorbents 000, 101, 103, and 107.

Large Capacity High Flow DFU Intake Filter

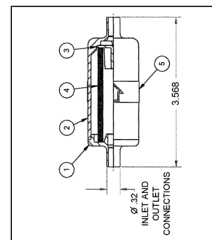

Model 9953-11

Specifications

Max. Pressure at 110°F (43°C): 2 psig (0.14 barg)
 Max. Temp. at 0 psig: 125°F
 Inlet / Outlet Ports: .032" OD
 Drain: None
 Housing Material of Construction: Polypropylene
 Internal Volume: 0.033L

Ordering Information

9953-11- Box of 10
 Available in Types Q and X and in the following grades: A, B, C, and D.
 Replacement element:
 050-11-?Q
 050-11-?X

Sample Filters

Filter Cartridge and Housing Selection



Disposable Adsorption Units (DAUs) contain a bed of adsorbent granules. Utilizing a wide choice of adsorbents, the DAUs selectively remove vapors from air and other gases.

Because the adsorbed vapor remains trapped in the solid bed, the DAU has a fixed upper limit of total weight of vapor which can be captured. It is usually not feasible to regenerate the filter when it has reached its adsorption limit. DAUs should be used only when small quantities of vapor are to be removed.

Considerations in Using Adsorbent Cartridges

The following factors should be considered when selecting a DAU:

- 1 Solid adsorbents are effective only for vapors. Since liquids will damage or inactivate most solid adsorbents, the DAU must be preceded by an efficient coalescing filter.
- 2 In contrast with Microfibre Filters, which operate at their initial efficiency throughout their life, adsorbent cartridges have a limited holding capacity. When the adsorption capacity is reached, no further adsorption occurs. The limiting capacity, or “break-through” point, is not sharply defined, and the exit vapor concentration will increase rapidly as saturation is approached. To avoid unwanted vapor contaminants downstream, it is necessary to change the adsorbent cartridge well before it has reached its ultimate adsorption capacity.
- 3 Adsorption is reversible, if operating conditions change, a vapor may desorb rather than adsorb. For example, if a temporary surge in vapor impurity concentration causes a relatively high concentration to be adsorbed on the solid, a subsequent decrease in inlet vapor composition will result in desorption of vapor from the solid to the gas stream.
- 4 The efficiency of a given adsorbent for a given vapor depends upon the specific operating conditions. Therefore, again in contrast to filtration, it is not possible to assign a single efficiency rating to an adsorbent. While it is not possible to predict or guarantee an adsorption efficiency for any specific set of conditions, it is possible to enhance the conditions beneficial to adsorption and avoid conditions which interfere with adsorption. Conditions which aid adsorption are: low temperature, high pressure, low flow rate, and absence of competing vapors (particularly water vapor).

Adsorbent	Grade	Use For
Carbon	000	Compressor oil vapors, C ₅ and heavier hydrocarbons, aromatics, oxygenated hydrocarbons, chlorinated organics, freons, carbon disulfide.
Silica Gel	101	Recommended only for water vapor.
Molecular Sieve Type 13X	103	Most C ₄ and lighter hydrocarbons, ethylene, propylene, acetylene, ethylene oxide, ammonia, mercaptans, sulfur hexafluoride, triethylamine, and smaller amines.
Mixed Sodium & Calcium Hydroxides	107	All acidic gases, including sulfur trioxide, sulfur dioxide, nitrogen dioxide, carbon dioxide, hydrogen sulfide, hydrogen chloride, phosphorus trichloride, boron trifluoride.

Notes:

1 Please refer to Ordering Information for complete explanation of nomenclature.

2 In DAU 9933-05-107 and DAU 9933-11-107, color indicator turns violet when adsorbent is spent.

3 In DAU 9933-05-101 and 9933-11-101, adsorbent turns pink when vapor capacity is reached.

4 Maximum operating temperature is 180°F (82°C).

Sample Filters

Stainless Steel In-Line Filter Housings: 1/4" and 1/2" Port Size

Stainless steel construction

Pressure to 5000 psig (345 barg)

Temperature to 600°F (315°C)

Ideal end use filter

Model 97S6

Miniature 316 stainless steel filter with 1/4" NPT in-line ports, and 5000 psig (345 barg) rating. Since it does not have a drain port, the Model 97S6 is used as an end-of-the-line compressed gas filter when little or no liquid is expected, or as a cylinder gas filter.

Models 30/12 and 30/25

Designed specifically for quantitative measurement of solids in gases to 600°F (315°C), the filter cartridge and element retainer disc in the Model 30 housings may be weighed as a unit (see notes below).



Model 97S6



Model 30/12 and 30/25

Sample
Filters

Principal Specifications

Model	97S6	30/12	30/25
Inlet and Outlet Ports	1/4" NPT	1/2" NPT	1/2" NPT
Drain Port	None	None	None
Materials of Construction			
Head	316SS	303SS	303SS
Bowl	316SS	304SS	304SS
Internals	316SS	303SS	303SS
Seals	Viton	Carbon Fiber	Carbon Fiber
Maximum Temperature	400°F (204°C)	600°F (315°C) (2)	600°F (315°C)(2)
Maximum Pressure	5000 psig (345 barg) (1)	100 psig (6.89 barg) (3)	100 psig (6.89 barg) (3)
Shipping Weight	0.75 lbs. (0.3 kg)	2 lbs. (0.9 kg)	3 lbs. (1.4 kg)
Dimensions	1.25"D X 3.1"L (3.2cm X 7.9cm)	1.9"D X 4.4"L (4.8cm X 11.2cm)	1.9"D X 8.6"L (4.8cm X 22cm)

Notes:

- 1 Maximum pressure ratings are for temperatures to 200°F (93°C). Please consult factory for maximum pressure ratings at elevated temperatures.
- 2 For temperatures greater than 600°F (315°C) consult factory for proper recommended seals
- 3 100 psig at 450°F (241°C).

Ordering Information

For assistance, call toll-free at 1-800-343-4048 8AM to 5PM Eastern Time

Filter Housing Model	97S6	30/12	30/25
Support Core, Required for Liquid Filtration	Included	N/A	N/A
Filter Cartridges	050-05-□	100-12-□	100-25-□
Important Notes:	X-type cartridges are not available for the Model 97S6. For high temperature quantitative measurement applications order 100-12-DH/BH-F896 for use with the 30/12 or 100-25-DH/BH-F896 for use with the 30/25.		

Sample Filters

High Flow Stainless Steel Filter Housings:
Moderate to High Pressure Applications

Stainless steel construction

Pressure to 5000 psig (345 barg)

Temperature to 400°F (204°C)

Ideal for high pressure applications

Models 27/35, 27/80 and 15/80S6

Model 27 housings are among the largest 316 stainless steel filters available with high pressure capability. The 27/35 and 27/80 housings are used when 800 psig rating is required. The 27/35-3000 and 27/80-3000 models are suitable for service up to 3000 psig. The Model 15/80S6 is designed for 2" pipe systems and pressures to 500 psig (35 barg).



Models 27/35 and 27/80
(27/35 Shown)



Models 26/35D-3000
and 26/35D-5000

Models 26/35D-3000 and 26/35D-5000

Model 26/35D filter housings are constructed of carbon steel for high pressure applications. The Model 26/35D-3000 is ASME Code stamped at the rated pressure of 3000 psig (207 barg). The Model 26/35D-5000 complies with ASME Code design criteria.

Sample Filters

High Flow Stainless Steel Filter Housings: Moderate to High Pressure Applications

Principal Specifications

Model	27/35	27/35-3000	27/80	27/80-3000	26/35D-3000,	26/35D-5000	15/80S6
Inlet and Outlet Ports	1" NPT	1" NPT	1" NPT	1" NPT	1" NPT	1" NPT	2" NPT
Drain Port	1/4" NPT	1/4" NPT	1/4" NPT	1/4" NPT	1/4" NPT	1/4" NPT	1/4" NPT
Materials of Construction							
Head	316SS (1)	316SS (1)	316SS (1)	316SS (1)	Carbon Steel	Carbon Steel	Stainless Steel
Bowl	316SS (1)	316SS (1)	316SS (1)	316SS (1)	Carbon Steel	Carbon Steel	Stainless Steel
Internals	316SS (1)	316SS (1)	316SS (1)	316SS (1)	Stainless Steel	Stainless Steel	Stainless Steel
Seals	Viton	Viton	Viton	Viton	Buna-N	Buna-N	Viton
Maximum Temperature	400°F(204°C)	400°F(204°C)	400°F(204°C)	400°F(204°C)	250°F(120°C)	250°F(120°C)	400°F(204°C)
Maximum Pressure	800 psig (55.2 barg) (2)	3000 psig (207 barg) (2)	800 psig (55.2 barg) (2)	3000 psig (207 barg) (2)	3000 psig (207 barg) (3)	5000 psig (345 barg) (3)	800 psig (35 barg) (2)
Shipping Weight	16 lbs (7.3 kg)	25 lbs. (11 kg)	33 lbs. (14.9 kg)	42 lbs. (19kg)	80 lbs. (36 kg)(4)	170 lbs.	32 lbs. (14.4 kg)
Dimensions	4.0"D X 16"L (10 cm X 41 cm)	4.3"D X 16"L (11 cm X 41 cm)	4.0"D X 27"L (10 cm X 69 cm)	4.3"D X 27"L (11 cm X 69 cm)	7.0"D X 17"L (18 cm X 93 cm)	8.5"D X 16.25"L	6.3"D X 28"L (16 cm X 71 cm)

Ordering Information

For assistance, call toll-free at 1-800-343-4048 8AM to 5PM Eastern Time

Filter Housing Model	27/35	27/35-3000	27/80	27/80-3000	26/35D-3000,	26/35D-5000	15/80S6
Support Core, Required for Liquid Filtration	SS-200-35	SS-200-35	SS-200-80	SS-200-80	Included	Included	SS-200-80
Filter Cartridges	200-35-□	200-35-□	200-80-□	200-80-□	200-35-□	200-35-□	200-80-□
Use only these cartridge types	X, H, Q, CI (5)	X, H, Q, CI (5)	X, H, Q, CI (5)	X, H, Q, CI (5)	X, H, Q, CI(5)	X, H, Q, CI(5)	X,H,Q,CI(5)

Notes:

1 Constructed of materials which comply with NACE Specification MR-01-75. Request certificate of compliance

2 Maximum pressure ratings are for temperatures to 200°F (93°C). Please consult factory for maximum pressure ratings at elevated temperatures.

3 Vessel is ASME Section VIII, Div. 1 code stamped for rated pressure at 200°F (93°C). For 5000 psig pressure rating without the ASME code stamp, order Model 26/35D-5000.

4 Shipping weight of Model 26/35-5000 is 170 lbs (77kg)

5 To order CI Cartridges, indicate type of adsorbent desired by putting three digit designation after size code. For example, to order a carbon cartridge for Model 27/35 housing, order CI-200-35-000. CI cartridges are sold in boxes of 1.

Sample Filters

High Pressure Filter Housings: For High Purity, Low Flow Applications

Stainless steel construction

Pressure to 5000 psig (345 barg)

Temperature to 400°F (204°C)

Ideal for removing solids and large quantities of liquids from gas

Model 85

The Model 85 filter housing is constructed of 316 stainless steel, and has a pressure rating of 5,000 psig (345 barg). This Model can accommodate extended life, X-type filter cartridges and is used when larger quantities of liquids are expected.

Models 37/12 and 37/25

These T-type filter housings are also constructed of 316 stainless steel, and have a 4000 psig (276 barg) rating. These models are used as sample filters for on-line sample analyzers when a larger line size, higher flow rate, or larger bowl reservoir capacity is required.



Model 85



Models 37/12, 37/25
(37/25 Shown)

Principal Specifications

Model	85	37/12	37/25
Inlet and Outlet Ports	1/4" NPT	1/2" NPT	1/2" NPT
Drain Port	1/4" NPT	1/8" NPT	1/8" NPT
Materials of Construction			
Head	316SS (1)	316SS (1)	316SS (1)
Bowl	316SS (1)	316SS (1)	316SS (1)
Internals	316SS (1)	316SS (1)	316SS (1)
Seals	Viton	Viton	Viton
Maximum Temperature	400°F (204°C)	400°F (204°C)	400°F (204°C)
Maximum Pressure	5000 psig (345 barg) (2)	4000 psig (276 barg) (2)	4000 psig (276 barg) (2)
Shipping Weight	4 lbs. (2 kg)	6 lbs. (3 kg)	10 lbs. (5 kg)
Dimensions	2.5"D X 5"L (6cm X 13cm)	2.75"D X 5.75"L (7cm X 14.6cm)	2.75"D X 10.25" L (7cm X 26cm)

Notes:

- 1 Constructed of materials which comply with NACE Specification MR-01-75. Request certificate of compliance
- 2 Maximum pressure ratings are for temperatures to 200°F (93°C). Please consult factory for maximum pressure ratings at elevated temperatures.
- 3 To order CI Cartridges, indicate type of adsorbent desired by putting three digit designation after size code. For example, to order a carbon cartridge for Model 27/35 housing, order CI-200-35-000. CI cartridges are sold in boxes of 1.

Ordering Information

For assistance, call toll-free at 1-800-343-4048 8AM to 5PM Eastern Time

Filter Housing Model	85	37/12	37/25
Support Core, Required for Liquid Filtration	Included	SS-100-12	SS-100-25
Filter Cartridges	050-11-□	100-12-□	100-25-□
Use only these filter cartridge types	X, H, Q	X, H, Q, CI, SMF (3)	X, H, Q, CI (3)

Sample Filters

Stainless Steel Filter Housings: For Liquids with a High Solids Content

Stainless steel construction

Pressure to 425 psig (30 barg)

Temperature to 220°F (104°C)

Models 33S6 and 45S6

Models 33S6 and 45S6 Filter Housings are constructed of stainless steel and have 1/2" NPT ports. The Model 33S6 uses a 2 1/2" long filter cartridge, and the Model 45S6 uses a 7" long filter cartridge. Both filters are also available with a transparent Pyrex glass bowl (100 psig/7 barg rating) with breakage-protecting external plastic shield.

Models 33G and 45G

These models offer a transparent Pyrex glass bowl (100 psig rating) with breakage-protecting external plastic shield. They also offer convenient molded gaskets to ensure quick and safe filter change-outs.

Filter Cartridges

X-type cartridges with integral prefilters are recommended for filtration of all liquids with high solids content, including samples from cooling water, well water, and effluent streams.



Models 33S6 and 45S6
(45S6 Shown)



Models 33G and 45G
(45G Shown)

Sample
Filters

Principal Specifications

Model	33G	45G	33S6	45S6
Inlet and Outlet Ports	1/2" NPT (1)	1/2" NPT (1)	1/2" NPT (1)	1/2" NPT (1)
Drain Port	1/8" NPT	1/8" NPT	1/8" NPT	1/8" NPT
Materials of Construction				
Head	316SS	316SS	316SS (5)	316SS (5)
Bowl	Pyrex	Pyrex	316SS (5)	316SS (5)
Internals	316SS	316SS	316SS (5)	316SS (5)
Seals	Viton	Viton	Viton	Viton
Maximum Temperature	160°F (71°C) (2)	160°F (71°C) (2)	400°F (204°C) (3)	400°F (204°C) (3)
Maximum Pressure	100 psig (6.89 barg) (3)	100 psig (6.89 barg) ((3)	425 psig (29.3 barg) ((3)	250 psig (17.24 barg) ((3)
Shipping Weight	3 lbs (1.4 kg)	5 lbs. (2.3 kg)	3 lbs. (1.4 kg)	5 lbs. (2.3 kg)
Dimensions	2.6"D X 4.5"L (6.7cm X 12cm)	2.6"D X 9.3"L (6.7cm X 24cm)	2.6"D X 4.5"L (6.6cm X 11.4cm)	2.6"D X 9"L (6.6cm X 22.9cm)

Notes:

1 Also available with 1/4" ports. To order with 1/4" NPT ports, use designation Model 33G-1/4, etc.

2 Limited by maximum temperature of acrylic bowl guards.

3 Maximum pressure ratings are for temperatures to 160°F (71°C). Please consult factory

for maximum pressure ratings at elevated temperatures.

4 Support core for use with X-type cartridges. Flow is outside to inside.

Consult factory for maximum pressure ratings at elevated temperatures.

5 Materials comply with NACE Specification MR-01-75. Request certificate of compliance.

Ordering Information

For assistance, call toll-free at 1-800-343-4048 8AM to 5PM Eastern Time

Filter Housing Model	33G	45G	33S6	45S6
Filter Cartridge	100-12-□	100-25-□	100-12-□	100-25-□
Use only these Filter cartridge types	LP, M, X, CI	LP, X, CI	LP, M, X, CI	LP, X, CI
Support Core (optional) (4)	SS-100-12 (4)	SS-100-25 (4)	SS-100-12 (4)	SS-100-25 (4)

Sample Filters

Miniature Filter Housings: Convenient T-type Filters

Stainless steel, PTFE, or Monel construction

Pressure to 5000 psig (345 barg)

T-type construction allows for non-disruptive maintenance

Ideal sample filters for on-line analyzers

Models 91S6, 95A, 95M, 95S6, 95T, 105S6

These models are miniature T-type filters constructed of 316 stainless steel (5000 psig/345 barg), PTFE (150 psig/10.3 barg), and other specialty materials. With only 19 ml internal volume and the opportunity for by-pass or slipstream filtration using the drain port as an exit port, the model 95 filters are ideal sample filters for on-line analyzers. The model 105S6 has a small internal volume of 15 ml, which is ideal for applications requiring fast sampling response time.



Models 91S6, 95A, 95M, 95S6, 95T
(95S6 Shown)



Model 105S6

Principal Specifications

Model	105S6	91S6	95A	95M	95S6	95T
Inlet and Outlet Ports	1/8" NPT (1)	1/8" NPT (1)	1/8" NPT (1)	1/8" NPT (1)	1/8" NPT (1)	1/8" NPT (1)
Drain Port	1/8" NPT	1/8" NPT	1/8" NPT	1/8" NPT	1/8" NPT	1/8" NPT
Materials of Construction						
Head	316SS (2)	316SS (2)	Aluminum	Monel	316SS (2)	PTFE (2)
Bowl	316SS (2)	316SS (2)	Aluminum	Monel	316SS (2)	PTFE (2)
Internals	316SS (2)	316SS (2)	Aluminum	Teflon	316SS (2)	PTFE (2)
Seals	Viton	Viton	Viton	Viton	Viton	PTFE/Viton
Maximum Temperature	400°F (204°C)	400°F (204°C)	200°F (93°C)	400°F (204°C)	400°F (204°C)	300°F (149°C)
Maximum Pressure	5000 psig (345 barg) (3)	1500 psig (103 barg) (3)	2500 psig (172 barg) (3)	5000 psig (345 barg) (3)	5000 psig (345 barg) (3)	150 psig (10.3 barg) (3)
Shipping Weight	1 lb. (0.4 kg)	1 lb. (0.4 kg)	0.5 lb. (0.2 kg)	1 lb. (0.4 kg)	1 lb. (0.4 kg)	0.5 lb. (0.2 kg)
Dimensions	1.8"D X 3.3"L (4cm X 8cm)	1.5"D X 3.7"L (3.8cm X 9.4cm)	1.8"D X 4"L (4cm X 10cm)	1.8"D X 4"L (4cm X 10cm)	1.8"D X 4"L (4.6cm X 10.2cm)	1.8"D X 4"L (4.6cm X 10.2cm)

Notes:

1 Also available with 1/4" NPT ports. To order with 1/4" NPT ports, use designation Model 95S6-1/4, etc.

2 Constructed of materials which comply with NACE Specification MR-01-75. Request certificate of compliance.

3 Maximum pressure ratings are for temperatures to 200°F (93°C). Please consult factory for maximum pressure ratings at elevated temperatures.

Ordering Information For assistance, call toll-free at 1-800-343-4048 8AM to 5PM Eastern Time

Model	105S6	91S6	95A	95M	95S6	95T
Support Core, Required for Liquid Filtration	Included	Included	Included	Included	Included	Included
Filter Cartridges	050-07-□	050-11-□	050-11-□	050-11-□	050-11-□	050-11-□
Use only these filter types	Q, H, S	Q, H, S	Q, H, S	Q, H, M, S	Q, H, M, S	Q, H, M, S

Sample Filters

Low Internal Volume Filter Housings: 1/4" and 1/2" Port Size

Stainless steel construction

Pressure to 250 psig (17 barg)

Temperature to 400°F (204°C)

Compact design

Models 91S6, 31S6, 31G, 41S6, 41G

These models offer compact designs and half the dead volume of other sample filters resulting in faster sampling times. They are constructed of stainless steel and available with a variety of seals for easy adaptation to demanding applications. If larger amounts of condensate are expected, specify 33 or 45 series.



Models 31G, 41G
(41G Shown)



Model 91S6



Models 31S6, 41S6
(31S6 Shown)

Sample
Filters

Principal Specifications

Model	91S6	31G	41G	31S6	41S6
Inlet and Outlet Ports	1/8" NPT (1)	1/2" NPT (1)	1/2" NPT (1)	1/2" NPT (1)	1/2" NPT (1)
Drain Port	1/8" NPT	1/4" NPT	1/4" NPT	1/4" NPT	1/4" NPT
Materials of Construction					
Head	316SS (2)	316SS	316SS	316SS	316SS
Bowl	316SS (2)	Pyrex	Pyrex	316SS	316SS
Internals	316SS (2)	316SS	316SS	316SS	316SS
Seals	Viton	Viton	Viton	Viton	Viton
Maximum Temperature	400°F (204°C)	160°F (71°C)	160°F (71°C)	400°F (204°C)	400°F (204°C)
Maximum Pressure	1500 psig (103 barg) (3)	100 psig (6.9 barg) (3)	100 psig (6.9 barg) (3)	425 psig (29.3 barg) (3)	250 psig (17.2) (3)
Shipping Weight	1 lb. (0.4 kg)	2 lbs (0.9 kg)	4 lbs (1.8 kg)	3 lbs (1.4 kg)	5 lbs (2.3 kg)
Dimensions	1.5"D X 3.7"L (3.8cm X 9.4cm)	2.2"D X 5.5"L (5.7cm X 14cm)	2.2"D X 10.0"L (5.7cm X 26cm)	2.25"D X 5.5"L (5.7cm X 14cm)	2.25"D X 10"L (5.7cm X 25.4cm)

Notes:

1 Also available with 1/4" NPT ports. To order with 1/4" NPT ports, use designation Model 31G-1/4 etc.

2 Constructed of materials which comply with NACE Specification MR-01-75. Request certificate of compliance.

3 Maximum pressure ratings are for temperatures to 200°F (104°C). Please consult factory for maximum pressure ratings at elevated temperatures.

Ordering Information

For assistance, call toll-free at 1-800-343-4048 8AM to 5PM Eastern Time

Filter Housing Model	91S6	31G	41G	31S6	41S6
Support Core, Required for Liquid Filtration	Included	SS-100-12	SS-100-25	SS-100-12	SS-100-25
Filter Cartridges	050-11-□	100-12-□	100-25-□	100-12-□	100-25-□
Use only these Filter cartridge types	Q, H, M, S	X, H, Q, M, S	X, H, Q, S	X, H, Q, M, S	X, H, Q, S

Sample Filters

High Internal Volume Filter Housings: For Removing Large Volumes of Contaminants

Stainless steel construction

Pressure to 425 psig (30 barg)

Temperature to 400°F (204°F)

Ideal when a large volume of condensed liquid is expected

Models 33S6, 33G, 45S6, 45G

These models are higher flow rate filters. All models are available with 1/4" or 1/2" NPT ports. These filters are also available with clear Pyrex glass bowls (125 psig rating) with breakage protecting external plastic shields. These housings are useful for gas sampling when a large volume of suspended liquid is expected.



Models 33S6 and 45S6
(45S6 Shown)



Models 33G and 45G
(45G Shown)

Principal Specifications

Model	33G	33S6	45G	45S6
Inlet and Outlet Ports	1/2" NPT (1)	1/2" NPT (1)	1/2" NPT (1)	1/2" NPT (1)
Drain Port	1/8" NPT	1/8" NPT	1/8" NPT	1/8" NPT
Materials of Construction				
Head	316SS	316SS	316SS	316SS
Bowl	Pyrex	316SS	Pyrex	316SS
Internals	316SS	316SS	316SS	316SS
Seals	Viton	Viton	Viton	Viton
Maximum Temperature	160°F (71°C) (2)	400°F (204°C) (3)	160°F (71°C) (2)	400°F (204°C) (3)
Maximum Pressure	125 psig (8.6 barg) (2)	425 psig (30 barg) (2)	125 psig (8.6 barg) (2)	250 psig (17.2 barg) (2)
Shipping Weight	3 lbs./1.4kg	3 lbs./1.4 kg	5 lbs./2.3 kg	5 lbs./2.3 kg
Dimensions	2.6"D X 4.5"L (7cm X 11cm)	2.6"D X 4.5"L (6.6cm X 11.4cm)	2.6"D X 9.3"L (6.6cm X 22.9cm)	2.6"D X 9"L (6.6cm X 22.9cm)

Notes:

1 Also available with 1/4" NPT ports. To order with 1/4" NPT ports, use designation Model 33G-1/4, etc.

2 Limited by maximum temperature of acrylic bowl guards.

3 Maximum pressure ratings are for temperatures to 200°F (93°C). Please consult factory for maximum pressure ratings at elevated temperatures.

4 To order CI Cartridges, indicate type of adsorbent desired by putting three digit designation after size code. For example, to order a carbon cartridge for Model 27/35 housing, order CI-200-35-000. CI cartridges are sold in boxes of 1.

Ordering Information

For assistance, call toll-free at 1-800-343-4048 8AM to 5PM Eastern Time

Model	33G	33S6	45G	45S6
Support Core, Required for Liquid Filtration	SS-100-12	SS-100-12	SS-100-25	SS-100-25
Filter Cartridges Use only these	100-12-□	100-12-□	100-25-□	100-25-□
filter cartridge types	X, H, Q, M, CI	X, H, Q, M, CI	X, H, Q, CI, M	X, H, Q, CI, M

Sample Filters

Plastic Filter Housings: 1/4" to 3/4" Line Size

Filter solids and liquids from gases with 99.99% efficiency at 0.01 micron

Liquid filtration efficiency to 1 micron

Temperature to 230°F (110°C)

Model 90

The Model 90 filter holder is designed to accept grade X or Q type filter cartridges. This model is used as the inlet filter on air, gas or liquid sample analyzers. It can also be used as a vent/breather filter on storage vessels. The disposable filter cartridge is easily replaced in the field, requiring no tools.



Model 90

Model 58P

The Model 58P housing has a nylon head and internals and a transparent nylon bowl, and replaceable filter cartridges. It is used for filtration of water or mildly acidic or caustic solutions.



Model 58P

Model 53

The Model 53 housings are constructed of polypropylene, and are designed for a single LP-200 filter cartridge in 5", 10", or 20" lengths. The polypropylene construction provides excellent resistance to non-oxidizing acids, such as HCL in any concentration, sulfuric to 70% concentration, brines, hydrocarbon liquids, alcohols, and concentrated caustic. The Model 53 can be used with certain ketones and chlorinated solvents.



Model 53/18

Model 54

The Model 54 housings have a polypropylene head and a transparent styrene-acrylonitrile (SAN) bowl. The transparent bowl is available only in the 10" length. Model 54 housings are used for filtration of water or mildly acidic solutions at temperatures below 100°F (38°C).



Models 54/50 and 53/50
(53/50 Shown)

Sample Filters

Plastic Filter Housings: 1/4" to 3/4" Line Size

Principal Specifications

Model	90	58P	53/18	53/50	54/50
Inlet and Outlet Ports	1/4" Tubing	1/4" NPT	3/8" NPT	3/4" NPT	3/4" NPT
Materials of Construction					
Head	Polyprop.	Nylon	Polyprop.	Polyprop.	Polyprop.
Bowl	Polyprop.	Nylon	Polyprop.	Polyprop.	SAN
Internals	—	Nylon	Polyprop.	Polyprop.	Polyprop.
Seals	—	—	EPR	EPR	EPR
Maximum Temperature	230°F (110°C)	150°F (66°C)	125°F (52°C)	125°F (52°C)	100°F (38°C)
Maximum Pressure	60 psig (4.1 barg) (1)(2)	125 psig (4.1 barg) (1)	125 psig (4.1 barg) (1)	125 psig (4.1 barg) (1)	125 psig (8.6 barg) (1)
Shipping Weight	0.2 lbs. (0.1 kg)	1lbs. (0.5 kg)	3 lbs. (1.4 kg)	4 lbs. (1.8 kg)	4 lbs. (1.8 kg)
Dimensions	1.4"D X 3.8"L (4cm X 10cm)	2.7"D X 6.1"L (7cm X 16cm)	5"D X 6.6"L (11cm X 17cm)	5"D X 12"L (13cm X 30cm)	5"D X 12"L (13cm X 30cm)

Notes:

1 Maximum pressure ratings are for temperatures to 125°F (52°C). Please consult factory for maximum pressure ratings at elevated temperatures.

2 60 psig (4.1 barg) pressure rating with flow direction from inside to out. Consult factory for other operating conditions.

Ordering Information

For assistance, call toll-free at 1-800-343-4048 8AM to 5PM Eastern Time

Filter Housing	90	58P	53/18	53/50	54/50
Filter Cartridge	100-12-□	LP-100-12-□	LP-200-18-□	LP-200-50-□	LP-200-50-□

Sample Filters

Filters for Vehicle Emission Analyzers: Filter System for Gas Engine Analyzers

**Complete removal of solid particles,
condensed water, and oils**

**Long filter life, even in high use
conditions**

**No effect by the filter on the composition
of the gas**

Complete resistance to corrosion

Model 58N

The Model 58N housing is a rugged, economical housing with a 1/8" NPT drain. The transparent polycarbonate bowl and the nylon head, tie rod, and element retainer are resistant and non-absorbent to all components of the sample stream. The Balston 58N filter housing has much better corrosion resistance and is more economical than other filters used in this application.

The Balston Grade 404 Microfibre Filter Cartridges were developed specifically for use in sample lines to Gasoline Engine Analyzers. The filter cartridges are composed of borosilicate glass and polyolefin fibers. They have a 93% retention efficiency at 0.1 micron and offer a significantly higher solids holding capacity and lower pressure drop than conventional resin-bonded glass microfibre filter cartridges. The Balston Grade 404 filter cartridges are hydrophobic and drain water much more rapidly than all-glass fiber cartridges, greatly reducing the possibility of loss of NO₂ and other water-soluble components from the gas sample.

When installed with inside-to-outside flow direction, the Grade 404 filter cartridges are efficient, fast-draining coalescing filters. When installed with outside-to-inside flow direction, the pure white surface of the filter tube permits quick visual estimation of the dirt loading on the filter cartridge.

In addition to the standard 100-12 size, Grade 404 Microfibre Filter Cartridges are available in sizes to fit all Vehicle Emission Analyzer filter housings.



Model 58N

Model	58N
Inlet and Outlet Ports	1/4" NPT
Drain Port	1/8" NPT
Materials of Construction	
Head	Nylon
Bowl	Polycarbonate
Internals	Nylon
Seals	Buna
Maximum Temperature	150°F (66°C)
Maximum Pressure	10 psig (0.7 barg)
Shipping Weight	1lb. (0.5 kg)
Dimensions	2.8"D X 6.3"L (7cm X 16cm)

Filter Housing Model	58N
Replacement Filter Cartridges (box of 10)	100-12-404
	Note: Filter cartridge not included. Must be ordered separately

Sample Filters

Filters for Diesel Engine Analyzers: Remove Impurities from Gas Stream

Totally inorganic filter cartridge is inert and contains no extractables

Temperature capability to 450°F (232°C)

Filter housing designed for convenient external heating

The Problem:

Diesel engine exhaust has a much higher concentration of suspended solid particles and nonvolatile liquid droplets.

Diesel engine exhaust has a high dew point and must be kept hot to prevent liquid condensation which would affect the accuracy of the analysis. To avoid contamination of sample lines with dirt and oil, most diesel engine analysis systems are designed with the primary filter close to the inlet of the sample system. The filter is externally heated to prevent liquid condensation when the system is started up, but during prolonged operation, the filter often is subjected to engine exhaust gas temperatures, which normally range from 350°F to 450°F (176°C to 232°C) and occasionally get as high as 600°F (315°C).

The Solution:

Model 38 filters, designed specifically for diesel engine exhaust, are all-stainless steel housings with silicone seals (maximum temperature 600°F/315°C). The 1/4" NPT inlet and outlet ports are located at one end of the cylindrical body, and the bayonet closure for changing the filter cartridge is located at the opposite end. To maintain constant temperature, the body may be wrapped in heating tape or enclosed in an oven. The novel closure design permits an operator wearing gloves to replace a filter element rapidly, without disturbing the heating provisions or gas flow connections. The filter housing may be oriented horizontally, vertically, or at any other convenient attitude.

The standard size Model 38/25 housing has a 10-inch (25 cm) long body. Where the installation requires a smaller size housing, the Model 38/12 with 5 1/2 inch (14 cm) long body is available.



Model 38/12, 38/25
(38/25 Shown)

The Grade DH21 filter cartridge, composed of borosilicate glass microfibers and inorganic binder, is inert to all components in the gas and stable to 900°F (482°C). The retention efficiency is 93% of 0.1 micron particles and 100% of 2 micron and larger particles. With flow direction through the filter tube inside-to-outside, the internal prefilter in the Grade DH21 cartridge provides satisfactory life in a relatively dirty environment. Since the dirt is trapped on the inside of the cartridge, the external surface of the cartridge and the filter housing remain free of contaminants.

Principal Specifications

Model	38/12	38/25
Inlet and Outlet Ports	1/4" NPT	1/4" NPT
Materials of Construction		
Head	Stainless Steel	Stainless Steel
Bowl	Stainless Steel	Stainless Steel
Internals	Stainless Steel	Stainless Steel
Seals	Silicone	Silicone
Maximum Temperature	450°F (232°C)	450°F (232°C)
Maximum Pressure	20 PSIG (1.4 barg)	20 PSIG (1.4 barg)
Shipping Weight	5 lbs. (2.3 kg)	4 lbs. (1.8 kg)
Dimensions	2.25"D x 5.5"L (1) (6cm x 14cm)	2.25"D x 10.0"L (1) (6cm x 25cm)

Ordering Information

Filter Housing Model	Filter Cartridge
38/25 (box of 10) Standard Length	100-25-DH21 (2)
38/12 (box of 10) Short Length	100-12-DH21 (2)

Note: Filter cartridge not included. Must be ordered separately.

Notes:

1 Dimension without handle. Handle adds 3.75" (9.5 cm).

2 If an H-Type filter cartridge is being used, order a modified element retainer kit, P/N 30205.

Sample Filters

Series 98 Membrane Filters: Hydrophobic Membrane Protection

Ideal for protecting GCs, Mass Spectrometers, O₂ Analyzers, and Moisture Analyzers

Removes entrained water, submicron sulfuric acid aerosol, and ultra fine particulate

Much lower initial cost and operating costs than other membrane filters



Series 98 Membrane Filter

Series 98 Membrane Filter

The Series 98 Membrane Filter consists of a housing with a porous membrane filter, which is supported by a sintered porous disk located on the “outlet” side of the housing. Gas enters through the “inlet” port on the upstream side of the membrane, and exits from the “outlet” port on the downstream side. Entrained liquid will not flow through the membrane, and will exit through the “bypass” port on the upstream side of the membrane, completely protecting sensitive instrumentation from moisture. Two models are available: The 98-0 (standard) and the 98-2 (high flow). The 98 Series is identical to other hydrophobic membranes offering the same performance and features but at a much lower price.

The Membrane

Microscopic pores contained within the membrane permit molecules of gas or vapor to flow through easily, allowing the composition of the sample gas to remain unchanged. Even the smallest liquid molecules remain trapped and are unable to flow through the membrane’s small passages under normal operating conditions. This is due to the high surface tension which causes liquid molecules to bind tightly together to form a group of molecules, moving together, which is too large to fit through the pores of the membrane.

The membrane is extremely inert, and is recommended for most process liquid applications, with the exception of hydrofluoric acid. It is also recommended for use in systems designed for PPB, PPM, and “percent level” component concentrations, as a result of its very low absorption characteristics. The membrane is strong and durable, but also very soft and pliable.

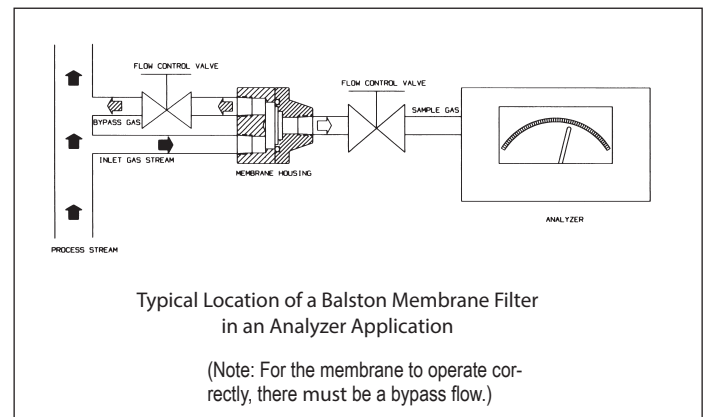

Sample Filters

Series 98 Membrane Filters: 1/4" Line Size

Sample Filters

How to Select the Membrane and Model

1. Determine the following application requirements:

- Gas flow rate to the analyzer excluding the bypass flow.
- Type of suspended liquid to be separated and amount normally present in the sample.
- Gas sample supply pressure at membrane filter inlet.

2 Use Table 1 to select a membrane filter model and membrane type which meet your application requirements. Note that the membrane differential pressure for the model and membrane type selected must be lower than the available gas sample supply pressure.

Selecting the Appropriate Type of Membrane

There are two basic types of membranes for the 98 Series Membrane Filters: The Model 98-0 (Standard) is suitable for separation of most liquids from gases. The Model 98-2 (High Flow) is best suited for the separation of water and other high surface-tension liquids from gases.

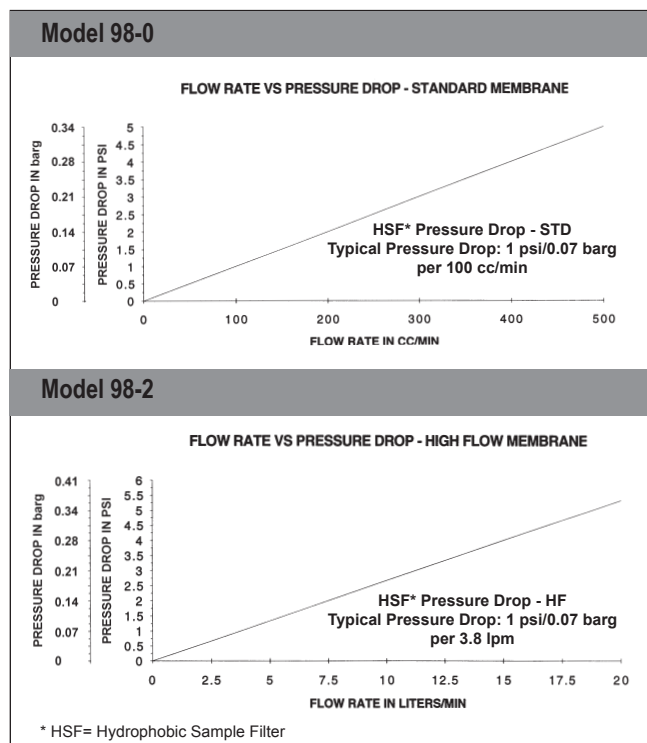

Table 1 Housing and Membrane Selection GuidePrincipal

Model	98-0	98-2
Membrane Type	Standard (1)	High Flow (2)
Max. Recommended Flow Rate in L/Min.	0.60 (3)	10 (3)
Normal Amount of Liquid Present in Gas	Low to Medium (4)	Low to Medium (4)

Notes:

- Standard membrane is suitable for most suspended liquids.
- High flow membrane is suitable for suspended water, solutions consisting primarily of water, sulfuric acid, caustic, glycols, oily liquids, other high surface-tension type liquids.
- Maximum recommended flow rate of gas through the membrane. Does not include the "bypass" flow rate.
- Amount of liquid normally expected to be present in the sample gas: Low: aerosol or occasional droplets. Medium: continuous droplets. High: continuous flowing liquid.

Specifications

Model	98
Inlet, Outlet, Bypass Ports	1/4" NPT
Materials of Construction	
Housing	316 Stainless Steel (2)
O-rings	Viton (standard)
Kalrez, Buna, EPDM (optional)	
Maximum Operating Pressure	1000 psig @ 200°F (69 barg @ 93°C)
Maximum Temperature	212°F (100°C)
Maximum Flow Rate	
Standard Membrane	.60 L/Min.
High Flow Membrane	10 L/Min.
Typical Membrane Pressure Drop	
Standard Membrane	1 psig (0.07 barg) per 100 cc/min. flow through membrane (1)
High Flow Membrane	1 psig (0.07 barg) per 3.8 liters/min. flow through the membrane (1)
Outside Dimensions	2"D x 2"L (5cm X 5cm)
Shipping Weight	1.5 lbs. (0.7 kg)

Notes:

- Pressure Drops are for temperatures to 212°F (100°C).

Ordering Information

Filter Assembly Maintenance Kits	98-0 (Standard)	98-2 (High Flow)
98014	5 each Membranes & Viton O-Rings for 98-0	
98015	5 each Membranes & Viton O-Rings for 98-2	
98002	5 each Membranes 98-0	
98020	5 each Membranes 98-2	

Sample Filters

Series A98 Coalescer Membrane Combination Filters

A98 Series offers continuous coalescing of all liquid and the security of hydrophobic membrane protection all in one unit

Fewer fittings required - reducing risk of leaks

More compact - no need for separate coalescers

Less maintenance and downtime as the membrane is fully protected from solids & liquids

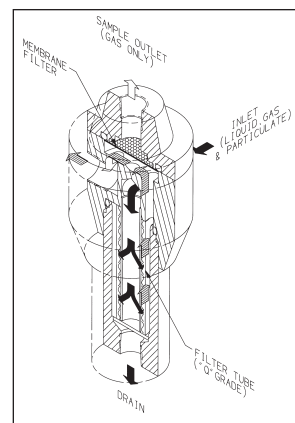

Series A98 Coalescer Membrane Combination Filter

Sample Filters

Series A98 Coalescer Membrane Combination Filter

The Balston Coalescer Membrane Combination Filter is designed to remove entrained liquid and particulate in gas samples for a wide variety of applications, and thereby prevents contamination or damage to the analyzers and sample system components. Typically located upstream from the analyzer or component it is protecting, the Coalescer Membrane Combination provides protection even if other sample system components fail.

The Coalescer Membrane Combination offers the performance and protection of the 98 Series Membrane Filter with the additional benefits of coalescing liquids and entrapment of particulates, offering maximum protection of the membrane. There is no need for prefiltration which places more volume in the sample system, and requires more space for installation and more potential for leaks.

The Series A98 consists of a housing with a porous membrane filter, which is supported by a sintered porous disk located on the "outlet" side of the housing. Gas enters through the "inlet" port and is directed down through the coalescing filter. The coalescer traps all particulates and continuously drains liquid contaminants. The sample gas then flows upward to the upstream side of the membrane, and exits from the "outlet" port on the downstream side. Entrained liquid will not flow through the membrane, and will exit through the drain port on the downstream side of the coalescer.

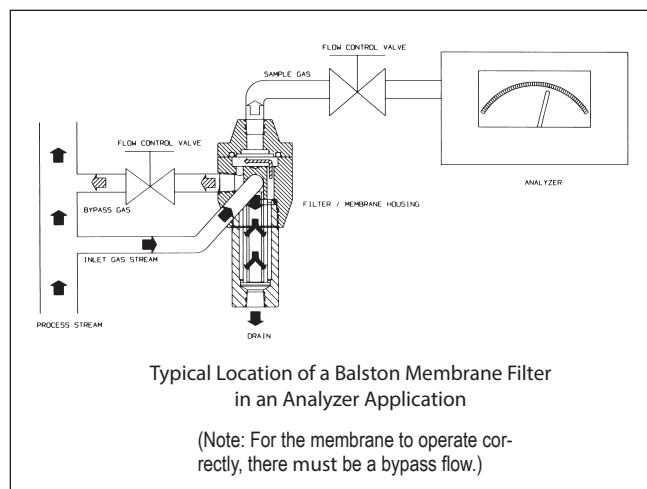

The Membrane

HSF* Pressure Drop - STD
Typical Pressure Drop: 1 psi per 100 cc/min

Microscopic pores contained within the membrane permit molecules of gas or vapor to flow through easily, allowing the composition of the sample gas to remain unchanged. Even the smallest liquid molecules remain trapped and are unable to flow through the membrane's small passages under normal operating conditions. This is due to the high surface tension which causes liquid molecules to bind tightly together to form a group of molecules, moving together, which is too large to fit through the pores of the membrane.

The membrane is extremely inert, and is recommended for most process liquid applications, with the exception of hydrofluoric acid. It is also recommended for use in systems designed for PPB, PPM, and "percent level" component concentrations, as a result of its very low absorption characteristics. The membrane is strong and durable, but also very soft and pliable.

Sample Filters

A98/11 Series Coalescer: Membrane Combination Filter

How to Select the Membrane and Model

1. Determine the following application requirements:

- Gas flow rate to the analyzer excluding the bypass flow.
- Type of suspended liquid to be separated and amount normally present in the sample.
- Gas sample supply pressure at Membrane Filter inlet.

2. Use Table 1 to select a Membrane Filter model and Membrane type which meet your application requirements. Note that the membrane differential pressure for the model and membrane type selected must be lower than the available gas sample supply pressure.

Selecting the Appropriate Type of Membrane

There are two basic types of membranes for the A98/11 Series Membrane Filters: The Model A98/11-__Q-0 (Standard) is suitable for separation of most liquids from gases. The Model A98/11-__Q-2 (High Flow) is best suited for the separation of water and other high surface-tension liquids from gases.

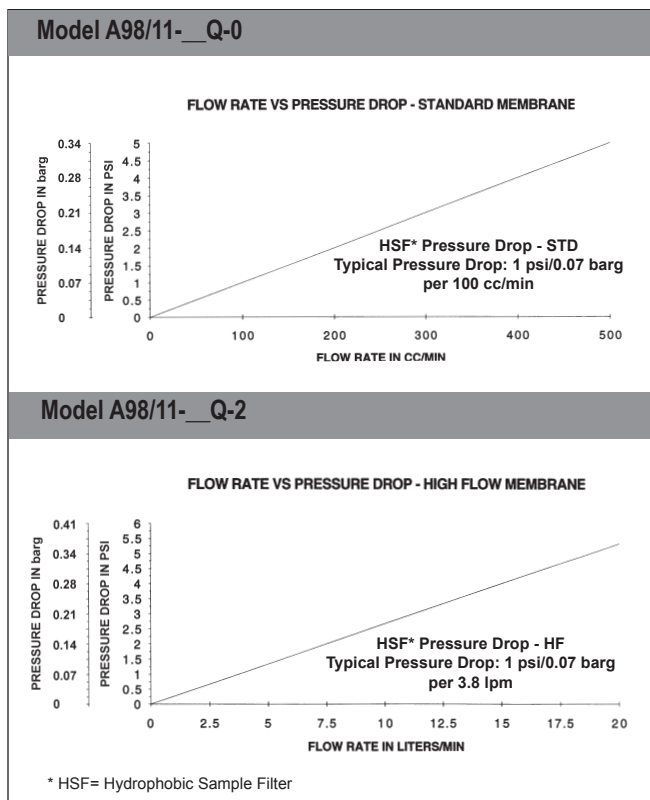

Table 1 Housing and Membrane Selection Guide

Model	A98/11-__Q-0	A98/11-__Q-2
Membrane Type	Standard (1)	High Flow (2)
Max. Recommended Flow Rate in L/Min.	0.60 (3)	10 (3)
Normal Amount of Liquid Present in Gas	Low to Medium (4)	Low to Medium (4)

Notes:

- Standard membrane is suitable for most suspended liquids.
- High flow membrane is suitable for suspended water, solutions consisting primarily of water, sulfuric acid, caustic, glycols, oily liquids, other high surface-tension type liquids.
- Maximum recommended flow rate of gas through the membrane. Does not include the "bypass" flow rate.
- Amount of liquid normally expected to be present in the sample gas: Low: aerosol or occasional droplets. Medium: continuous droplets. High: continuous flowing liquid.

Principal Specifications

Model	A98/11- [] Q - []
Inlet, Outlet, Bypass Ports	1/4" NPT
Materials of Construction	
Housing	316 Stainless Steel
O-rings	Viton (standard)
Kalrez, Buna, EPDM (optional)	
Maximum Operating Pressure	1000 psig @ 200°F (69 barg @ 93°C)
Maximum Temperature	212°F (100°C)
Maximum Flow Rate	
Standard Membrane	.60 L/Min.
High Flow Membrane	10 L/Min.
Typical Membrane Pressure Drop	
Standard Membrane	1 psig (0.07 barg) per 100 cc/min. flow through membrane (1)
High Flow Membrane	1 psig (0.07 barg) per 3.8 liters/min. flow through the membrane (1)
Outside Dimensions	2"D x 4"L (5cm X 10cm)
Shipping Weight	2.4 lbs. (1.1 kg)

Notes:

- Pressure Drops are for temperatures to 212°F (100°C).
- Constructed of materials which comply with NACE Specification MR-01-75. Request certificate of compliance.

Ordering Information

Filter/Membrane Replacement Kits	A98/11-__Q-0 A98/11-__Q-2
98011	5 ea. DQ Filters, Viton O-Rings and Membranes for A98/11-DQ-O
98012	5 ea. BQ Filters, Viton O-Rings and Membranes for A98/11-BQ-2
98013	5 ea. DQ Filters, Viton O-Rings and Membranes for A98/11-DQ-2
98010	5 ea. BQ Filters, Viton O-Rings and Membranes for A98/11-BQ-O
98002	5 ea. Membranes for A98-0 or A98/11_Q-O
98020	5 ea. Membranes for A98-2 or A98/11_Q-2
050-11-__Q	10 ea. Coalescing Filter Cartridges

Sample Filters

A39/12 Series Coalescer: Membrane Combination Filter

The A39/12 Series offers continuous coalescing of all liquid and the security of hydrophobic membrane protection all in one unit

Fewer fittings required - reducing risk of leaks

More compact - no need for separate coalescers

Less maintenance and downtime as the membrane is fully protected from solids & liquids

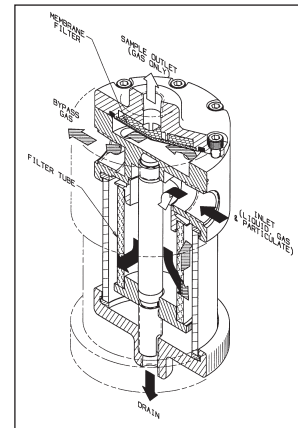

Series A39/12 Coalescer Membrane Combination Filter

Sample Filters

Series A39/12 Coalescer Membrane Combination Filter

The Balston Coalescer Membrane Combination Filter is designed to remove entrained liquid and particulate in gas samples for a wide variety of applications, and thereby prevents contamination or damage to the analyzers and sample system components. Typically located upstream from the analyzer or component it is protecting, the Coalescer Membrane Combination provides protection even if other sample system components fail.

The Coalescer Membrane Combination offers the performance and protection of the A39/12 Series Membrane Filter with the additional benefits of coalescing liquids and entrapment of particulates, offering maximum protection of the membrane. There is no need for prefiltration which places more volume in the sample system, and requires more space for installation and more potential for leaks.

The A39/12 Series consists of a housing with a porous membrane filter, which is supported by a sintered porous disk located on the “outlet” side of the housing. Gas enters through the “inlet” port and is directed down through the coalescing filter. The coalescer traps all particulates and continuously drains liquid contaminants. The sample gas then flows upward to the upstream side of the membrane, and exits from the “outlet” port on the downstream side. Entrained liquid will not flow through the membrane, and will exit through the drain port on the downstream side of the coalescer.

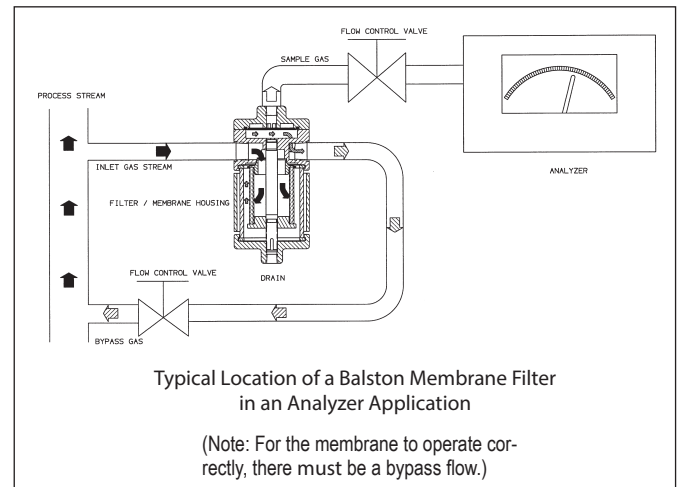

Typical Location of a Balston Membrane Filter in an Analyzer Application

(Note: For the membrane to operate correctly, there must be a bypass flow.)

The Membrane

Microscopic pores contained within the membrane permit molecules of gas or vapor to flow through easily, allowing the composition of the sample gas to remain unchanged. Even the smallest liquid molecules remain trapped and are unable to flow through the membrane's small passages under normal operating conditions. This is due to the high surface tension which causes liquid molecules to bind tightly together to form a group of molecules, moving together, which is too large to fit through the pores of the membrane.

The membrane is extremely inert, and is recommended for most process liquid applications, with the exception of hydrofluoric acid. It is also recommended for use in systems designed for PPB, PPM, and “percent level” component concentrations, as a result of its very low absorption characteristics. The membrane is strong and durable, but also very soft and pliable.

Sample Filters

A39/12 Series Coalescer: Membrane Combination Filters

How to Select the Membrane and Model

- Determine the following application requirements:
 - Gas flow rate to the analyzer excluding the bypass flow.
 - Type of suspended liquid to be separated and amount normally present in the sample.
 - Gas sample supply pressure at Membrane Filter inlet.
- Use Table 1 to select a Membrane Filter model and Membrane type which meet your application requirements. Note that the membrane differential pressure for the model and membrane type selected must be lower than the available gas sample supply pressure.

Selecting the Appropriate Type of Membrane

There are two basic types of membranes for the A39/12 Series Membrane Filters: The Model A39/12-0 (Standard) is suitable for separation of most liquids from gases. The Model A39/12-2 (High Flow) is best suited for the separation of water and other high surface-tension liquids from gases. A Pyrex bowl is available which offers full visibility of coalescing chamber.

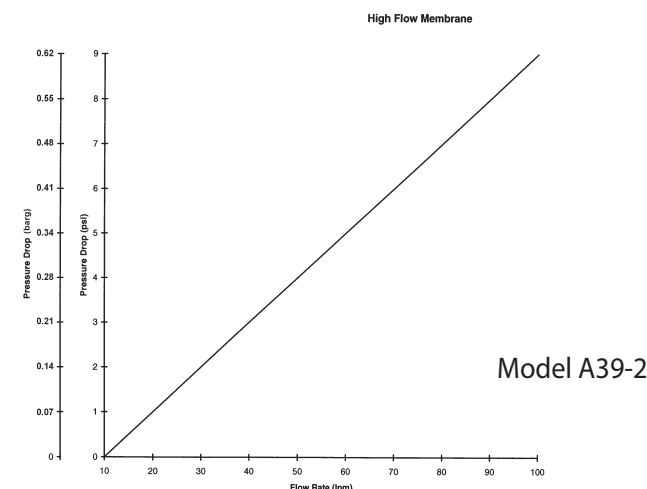
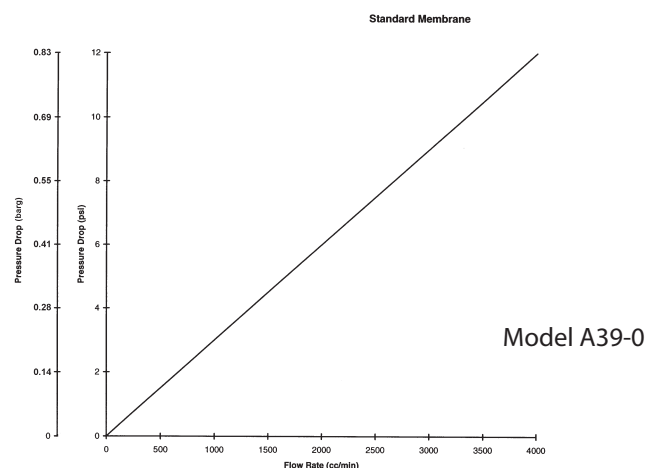

* HSF= Hydrophobic Sample Filter

Table 1 Housing and Membrane Selection Guide

Model	A39-0 Series	A39-2 Series
Membrane Type	Standard (1)	High Flow (2)
Max. Recommended Flow Rate in L/Min.	1.0 lpm (3)	70 lpm (3)
Normal Amount of Liquid Present in Gas	Low to Medium (4)	Low to Medium (4)

Notes:

- Standard membrane is suitable for most suspended liquids.
- High flow membrane is suitable for suspended water, solutions consisting primarily of water, sulfuric acid, caustic, glycols, oily liquids, other high surface-tension type liquids.
- Maximum recommended flow rate of gas through the membrane. Does not include the "bypass" flow rate.
- Amount of liquid normally expected to be present in the sample gas: Low: aerosol or occasional droplets. Medium: continuous droplets. High: continuous flowing liquid.

Principal Specifications

Model	A39/12 Series
Bypass Ports	1/2" NPT
Sample Port	1/4" NPT
Materials of Construction	
Housing	316 Stainless Steel (2)
O-rings	Viton (standard) Kalrez, Buna, EPDM (optional)
Maximum Operating Pressure	425 psig/29.3 barg @ 200°F/93°C (100 psig/6.9 barg @ 200°F/ 93°C with Pyrex bowl)
Maximum Temperature	212°F (100°C)
Maximum Flow Rate	
Standard Membrane	1 L/Min.
High Flow Membrane	70 L/Min.
Typical Membrane Pressure Drop	
Standard Membrane	1 psig (0.07 barg) per 250 cc/min. flow through membrane (1)
High Flow Membrane	1 psig (0.07 barg) per 20 liters/min. flow through the membrane (1)
Outside Dimensions	3.3"D x 7.3"L (8.4 cm X 18.5 cm)
Shipping Weight	7 lbs. (1.1 kg)

Notes:

- Pressure Drops are for temperatures to 212°F (100°C).
- Constructed of materials which comply with NACE Specification MR-01-75. Request certificate of compliance.

Ordering Information

Filter/Membrane Replacement Kits	A39/12-__X-0, A39/12-__X-2
39014	5 ea. Viton O-Rings and Membranes for A39/12-0
39015	5 ea. Viton O-Rings and Membranes for A39/12-2
39002	5 ea. Membranes for A39/12-0
39020	5 ea. Membranes for A39/12-2
150-12-__X	10 ea. Coalescing Filter Cartridges

Notes:

- For Glass Bowl version order: A39/12G-__X-(0)-(2)

Sample Filters

39 Series Membrane Filters

Ideal for protecting GCs, Mass Spectrometers, O₂ Analyzers, and Moisture Analyzers

Removes entrained water, submicron sulfuric acid aerosol, and ultra fine particulate

Much lower initial cost and operating costs than other membrane filters



39 Series

The 39 Series Membrane Filter

The 39 Series Membrane Filter consists of a housing with a porous membrane filter, which is supported by a sintered porous disk located on the “outlet” side of the housing. Gas enters through the “inlet” port on the upstream side of the membrane, and exits from the “outlet” port on the downstream side. Entrained liquid will not flow through the membrane, and will exit through the “bypass” port on the upstream side of the membrane, completely protecting sensitive instrumentation from moisture. Two models are available: The 39-0 (standard) and the 39-2 (high flow). The 39 Series is identical to other hydrophobic membranes offering the same performance and features but at a much lower price.

The Membrane

Microscopic pores contained within the membrane permit molecules of gas or vapor to flow through easily, allowing the composition of the sample gas to remain unchanged. Even the smallest liquid molecules remain trapped and are unable to flow through the membrane’s small passages under normal operating conditions. This is due to the high surface tension which causes liquid molecules to bind tightly together to form a group of molecules, moving together, which is too large to fit through the pores of the membrane.

The membrane is extremely inert, and is recommended for most process liquid applications, with the exception of hydrofluoric acid. It is also recommended for use in systems designed for PPB, PPM, and “percent level” component concentrations, as a result of its very low absorption characteristics. The membrane is strong and durable, but also very soft and pliable.

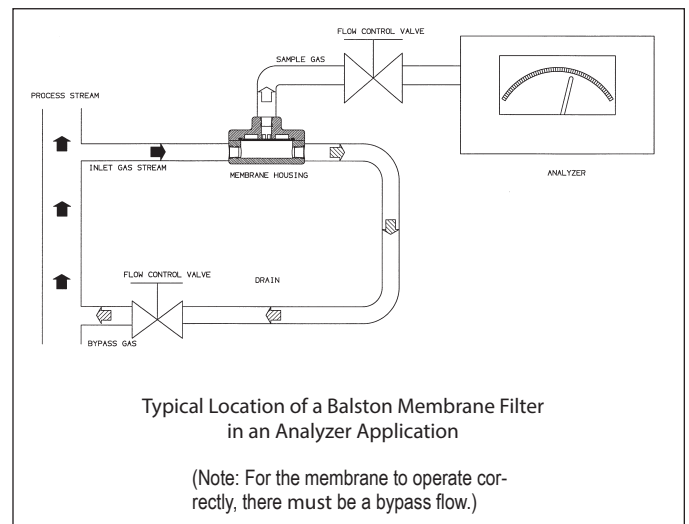

Sample Filters

39 Series Membrane Filters: 1/4" Line Size

How to Select the Membrane and Model

- Determine the following application requirements:
 - Gas flow rate to the analyzer excluding the bypass flow.
 - Type of suspended liquid to be separated and amount normally present in the sample.
 - Gas sample supply pressure at membrane filter inlet.
- Use Table 1 to select a membrane filter model and membrane type which meet your application requirements. Note that the membrane differential pressure for the model and membrane type selected must be lower than the available gas sample supply pressure.

Selecting the Appropriate Type of Membrane

There are two basic types of membranes for the 39-2 Series Membrane Filters: The Model 39-0 (Standard) is suitable for separation of most liquids from gases. The Model 39-2 (High Flow) is best suited for the separation of water and other high surface-tension liquids from gases.

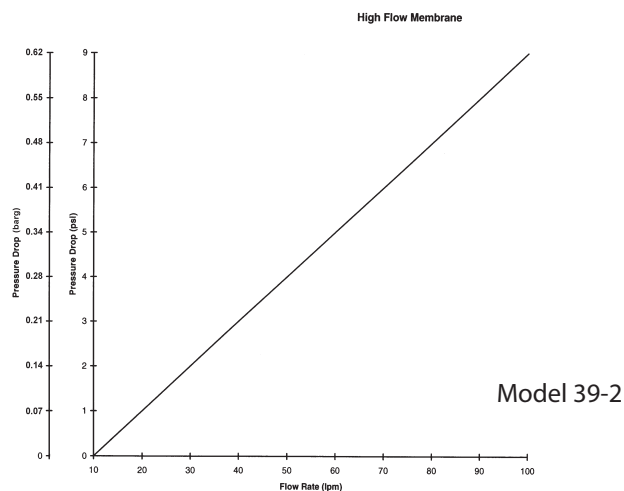
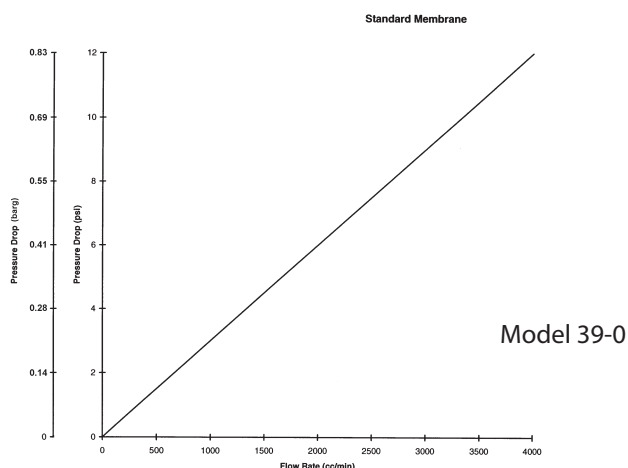

Table 1 Housing and Membrane Selection Guide

Model	39-0	39-2 Series
Membrane Type	Standard (1)	High Flow (2)
Max. Recommended Flow Rate in L/Min.	0.04 scfm (1.0 lpm) (3)	2.5 scfm (70 lpm) (3)
Normal Amount of Liquid Present in Gas	Low to Medium (4)	Low to Medium (4)

Notes:

- Standard membrane is suitable for most suspended liquids.
- High flow membrane is suitable for suspended water, solutions consisting primarily of water, sulfuric acid, caustic, glycols, oily liquids, other high surface-tension type liquids.
- Maximum recommended flow rate of gas through the membrane. Does not include the "bypass" flow rate.
- Amount of liquid normally expected to be present in the sample gas: Low: aerosol or occasional droplets. Medium: continuous droplets. High: continuous flowing liquid.

Principal Specifications

Model	39 Series
Bypass Ports	1/2" NPT
Sample Port	1/4" NPT
Materials of Construction	
Housing	316 Stainless Steel (2)
O-rings	Viton (standard) Kalrez, Buna, EPDM (optional)
Maximum Operating Pressure	500 psig (35 barg) @ 200°F (93°C) (100 psig (6.9 barg) @ 200°F (93°C) with Pyrex bowl)
Maximum Temperature	212°F (100°C)
Maximum Flow Rate	
Standard Membrane	0.04 scfm (1 L/Min.)
High Flow Membrane	2.5 scfm (70 L/Min.)
Typical Membrane Pressure Drop	
Standard Membrane	1 psig (0.07 barg) per 250 cc/min. flow through membrane (1)
High Flow Membrane	1 psig (0.07 barg) per 20 liters/min. flow through the membrane (1)
Outside Dimensions	3.3"D x 2"L (8.4cm X 5.1cm)
Shipping Weight	3 lbs. (1.4 kg)

Notes:

- Pressure Drops are for temperatures to 212°F (100°C).
- Constructed of materials which comply with NACE Specification MR-01-75. Request certificate of compliance.

Ordering Information

Filter/Membrane Replacement Kits	39-0, 39-2
39014	5 ea. Viton O-Rings and Membranes for 39-0
39015	5 ea. Viton O-Rings and Membranes for 39-2
39002	5 ea. Membranes for 39-0
39020	5 ea. Membranes for 39-2

Sample Filters

Fast Loop Filters: Filtration Efficiency from 100 μ m to 0.01 μ m

All 316 Stainless steel/Pyrex construction

Accepts Balston disposable microfibre filter cartridge and stainless steel cartridge

Compact design for fast response time

Process stream inlet/outlet ports and sample flow ports are identical, eliminating backup pressure in the system



Model 41GCFL-1/4

Description

Balston fast loop filters are constructed of 316 stainless steel with an optional stainless steel bowl or pyrex bowl. This flow through design continuously flushes the filter cartridge carrying the contaminants back out to the process stream, thus maximizing the filter cartridge life. The low flow sample stream pulled into the analyzer is filtered to ranges of 100 micron to 0.01 micron (depending on the filtration efficiency required). Two designs are available. The T-type design is suitable for high flow, high volume applications. The In-line design is ideal for heavily contaminated applications.

Operation

Axial velocity flushes the bulk contaminants through the filter housing back to the process stream. The sample stream passes through the filter cartridge wall with low flow and radial velocity. The clean side of the sample filter system has very low volume which minimizes lag time. A four to one flow rate is recommended to realize the benefits of prolonged filter cartridge life associated with continuous flushing.



Model 4856



Model 4956

Sample Filters

Fast Loop Filters: Filtration Efficiency from 100µm to 0.01µm

Principal Specifications

Model	31GCFL-1/4	31S6CFL-1/4	41GCFL-1/4	41S6CFL-1/4	48S6	49S6
Inlet and Outlet Ports	1/4" NPT	1/4" NPT	1/4" NPT	1/4" NPT	1/4" NPT	1/2" NPT
Drain Port	1/4" NPT	1/4" NPT	1/4" NPT	1/4" NPT	—	—
Materials of Construction						
Head	316 SS	316 SS (2) 316 SS	316 SS (2)	316 SS (2)	316 SS (2)	
Bowl	Pyrex (1)	316SS (1)(2)	Pyrex (1)	316 SS (1)(2)	316 SS (1)(2)	316 SS (1)(2)
Internals	316SS	316 SS (2) 316 SS	316 SS (2)	316 SS (2)	316 SS (2)	
Seals	Viton	Viton Viton	Viton	Viton	Viton	
Maximum Temperature	160°F (71°C)	400°F (204°C)	160°F (71°C)	400°F (204°C)	400°F (204°C)	400°F (204°C)
Maximum Pressure	100 psig (7 barg) (2)	425 psig (30 barg) (2)	100 psig (7 barg) (2)	250 psig (17 barg) (2)	5,000 psig (345 barg) (2)	1,500 psig (100 barg) (1)
Shipping Weight	2 lbs (0.9 kg)	3 lbs (1.4 kg)	4 lbs (1.8 kg)	5 lbs (2.3 kg)	1.1 lbs (0.2 kg)	2.5 lbs (0.4 kg)
Dimensions	2.2"D x 5.5"L (5.7cm x 14cm)	2.2"D x 5.5"L (5.7cm x 14cm)	2.2"D x 10"L (5.7cm x 25cm)	2.2"D x 10"L (5.7cm x 25cm)	1.35"D x 4"L (3.2cm x 10cm)	1.9"D x 7"L (4.8cm x 17.8cm)

Notes:

1 Maximum pressure ratings are for temperatures to 200°F (104°C). Please consult factory for maximum pressure ratings at elevated temperatures.

2 Constructed of materials which comply with NACE Specification MR-01-75. Request certificate of compliance.

Ordering Information

For Assistance, call toll-free at 1-800-343-4048 8AM to 5PM Eastern Time

Filter Housing Model	31GCFL-1/4	31S6CFL-1/4	41GCFL-1/4	41S6CFL-1/4	48S6	49S6
Support Core, Required for Liquid Filtration	SS-100-12	SS-100-12	SS-100-25	SS-100-25	Included	----
Filter Cartridges	100-12-□	100-12-□	100-25-□	100-25-□	050-11-□	100-185-□
Use only these Filter types	X, H, Q, M	X, H, Q, M	X, H, Q, M	X, H, Q, M	X, H, Q, M	X, H, Q

Sample Filters

Horizontally Mounted Sample Filter: Minimal Panel Space Required

Horizontal mounting minimizes space requirement on panel

All connections are made to the head eliminating the need to break the lines for filter changeouts

The only filter available that is mounted at an angle to ensure complete removal of all liquids

Includes cadmium plated steel mounting bracket



Model 47S6

Model 47S6

The Model 47S6 is designed to filter particulates and liquids from a gas sample, protecting on-line process analyzers from contamination. This unique design allows the filter to be mounted horizontally which minimizes the amount of space taken up on the panel.

It is also angled at 10° which ensures all collected liquids drain back to the drain port and not carried downstream to the analyzer. The drain port is drilled and tapped at an opposing angle eliminating the need to bend tubing.

Additionally, all connections (including the drain connection) are made to the head which eliminates the need to break the lines for filter changeouts.

This is an ideal filter for those applications requiring high efficiency filtration with the need for convenient filter changes on crowded panels.

Principal Specifications

Model	47S6
Inlet and Outlet Ports	1/4" NPT
Drain Port	1/4" NPT
Materials of Construction	316 SS (2)
Seals	Viton
Maximum Temperature	400°F (204°C)
Maximum Pressure	1500 psig (100 barg) (1)
Shipping Weight	1lb. (0.4 kg)
Dimensions	1.5"D X 3.7"L (4cm X 9cm)

Ordering Information

Filter Housing Model	47S6
Filter Cartridges	050-11-□
Use only these filter types	Q, H
Support Core required for liquid filtration	Included

Notes:

- 1 1500 psig @ 200°F (100 barg @90°C) consult factory for pressure ratings at elevated temperatures.
- 2 Constructed of materials which comply with NACE Specification MR-01-75. Request certificate of compliance.

Application Notes