

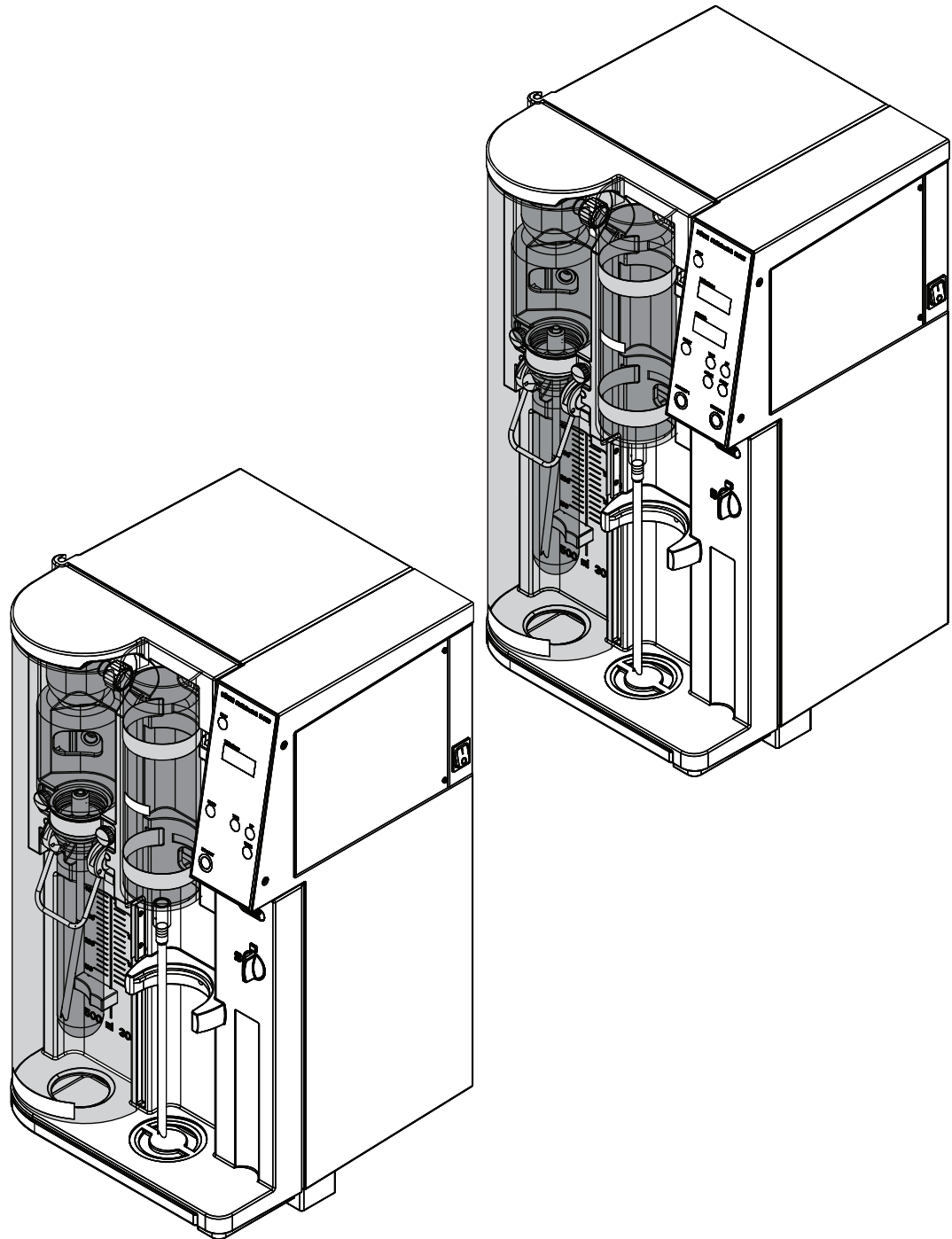

# Destillation Unit K-350 light / K-350 / K-355

## Technical data sheet

Easy to use basic distillation units for steam distillation based applications and the analysis of nitrogen and protein in all kinds of industries. The more advanced K-355 is perfectly suited for additional applications that require steam regulation and addition of acids.



## Overview

The K-350 light is dedicated to alcohol, ammonia and volatile acids distillation unit including the proven and powerful steam generator at a very attractive price.

The K-350 is an entry-level distillation unit for classical Kjeldahl analysis of food, beverage or environmental samples according to official methods.

The K-355 featuring an acid-resistant pump and adjustable steam power and in addition to Kjeldahl can be utilized for different kinds of steam distillations such as the determination of alcohol, sulfur dioxide, phenols, volatile acids, formaldehyde or TVB-N.

Feature	K-350 light	K-350	K-355
Timer	•	•	•
Display for distillation time	•	•	•
Display for steam power			•
Adjustable steam output			•
Pump for alkali dosage		•	•
Pump for acid dosage			•
Method memory			•
Choice of glass or plastic splash protector		•	•
Safety sensor service door	•	•	•
Safety sensor protecting door	•	•	•
Safety sensor sample tube detection	•	•	•
Sensor cooling water flow			•
Display of error message codes	•	•	•

## Order code Distillation Unit K-350 light

Choose the configuration according to your needs:

1 1 0 6 7 3 0 3

with glass splash protector slim without alkali inlet  
without NaOH pump

## Order code Distillation Unit K-350

Choose the configuration according to your needs:

0 4 3

Distillation Unit K-350

500 with glass splash protector

418 with plastic splash protector

## Order code Distillation Unit K-355

Choose the configuration according to your needs:

0 4 3

Distillation Unit K-355

505 with glass splash protector

419 with plastic splash protector

070 with glass splash protector and SO<sub>2</sub> determination kit

## Scope of delivery

All configurations are supplied ready to use.

Component	K-350 light	K-350	K-355
Sample tube (300 mL)	1	1	1
Storage tanks (10 L)	1	2	3
Hose for chemical feed (3.5 m)	-	1	1
Hose for cooling water feed (1.5 m)	-	1	1
Hose for cooling water drain (1.8 m)	-	-	1
Hose for cooling water drain (2.0 m)	1	1	-
Viton hose	-	-	1
Pair of glass tongs	1	1	1

## Technical data

### Distillation Unit

	K-350 light	K-350	K-355
Dimensions (W x D x H)	400 x 360 x 660 mm	400 x 360 x 660 mm	400 x 360 x 660 mm
Weight	16.5 kg	16.5 kg	17 kg
Timer	Yes	Yes	Yes
Display	distillation time	distillation time	distillation time, steam power
Steam power	100 %	100 %	30 – 100 % adjustable
Pumps	-	NaOH	NaOH, acid resistant pump
Measuring range (analyte nitrogen)	-	0.1 – 200 mg N	0.1 – 200 mg N
Power supply	230 V $\pm$ 10 %	230 V $\pm$ 10 %	230 V $\pm$ 10 %
Frequency	50/60 Hz	50/60 Hz	50/60 Hz
Power consumption	2200 W	2200 W	2200 W

### Ambient conditions

For indoor use only.

Ambient temperature	5 - 40°C
Maximum relative humidity	80%



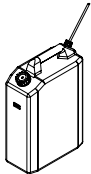
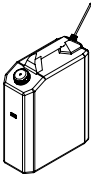

## Sample tubes and holders

	Order no.	Image
Sample tubes micro (100 mL) 4 pcs.	11057442	
Sample tubes 300 mL For sample volumes up to 200 mL or 5 g in weight 4 pcs.	037377	
Sample tubes 300 mL 20 pcs.	11059690	
Sample tubes graduated 300 mL 4 pcs.	043049	
Sample tube 500 mL	026128	
Sample tube 750 mL including suction tube	11058999	
Sample tube holder (4x 500 mL tubes)	016951	
Sample tube holder (6 x 300 mL tubes)	043039	
Sample tube holder (12 x 300 mL tubes)	043041	

## Storage tanks

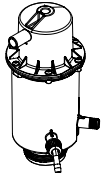
	Order no.	Image
Storage tank (10 L) for chemicals	043468	
Storage tank (20 L) for chemicals	043469	

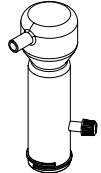
## Further accessories

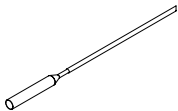
	Order no.	Image
Glass Splash Protector	043332	
Plastic Splash Protector	043590	
Glass splash protector Devarda	043335	
Glass splash protector slim without alkali inlet	11061393	
Glass set for SO <sub>2</sub> determination	048680	
Constricted distillate outlet tube PTFE = 5 mm	043096	

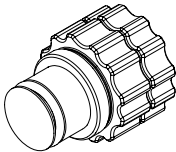
	Order no.	Image
<p>Cyanide caps</p> <p>Caps for hermetical closing of all types of Kjeldahl sample tubes during sample preparation for cyanide in food</p>	11067871	

## Hose set

	Order no.
Connecting hose set to chiller	11056900

## Documentation

	Order no.
<p>Kjeldahl Knowledge Base (EN)</p> <p>Comprehensive guide covering all aspects of the theoretical and practical know-how.</p>	11595478
<p>Kjeldahl Practice Guide (EN)</p> <p>Provides theoretical background information, useful hints and calculation tables for daily routine work</p>	11592548
Kjeldahl Practice Guide (DE)	11592547
Kjeldahl Practice Guide (CN)	11592549
<p>IQ/OQ set K-350 (EN)</p> <p>Complete set for Installation and Operational Qualification of the instrument</p>	045542
IQ/OQ set K-355 (EN)	045543
IQ/OQ set K-350 (DE)	11055437
IQ/OQ set K-355 (DE)	045655
Repeating OQ K-350 (EN)	11055489
Repeating OQ K-355 (EN)	11055491
Repeating OQ K-350 (DE)	11055490
Repeating OQ K-355 (DE)	11055492