

MULTIPLE PUMP XV-2

Ø 36,5 FLANGE

XV-2

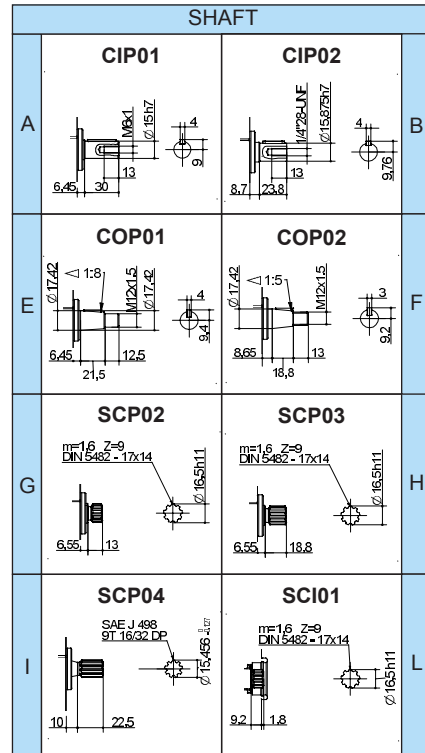
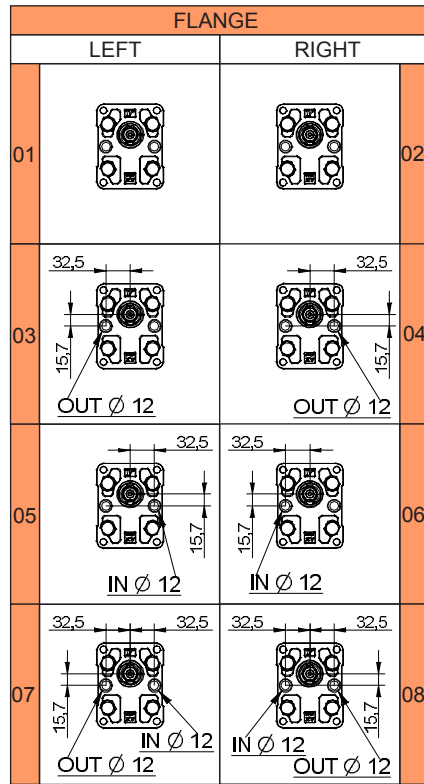
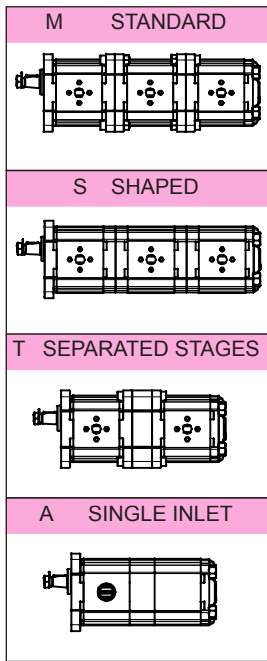

9 M 3 02 E C A 51 51 51

NUMBER OF ELEMENTS

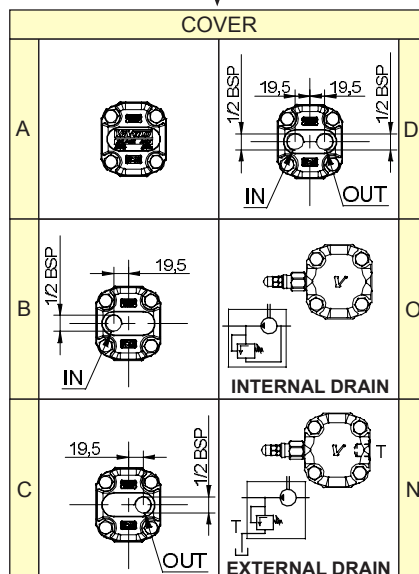
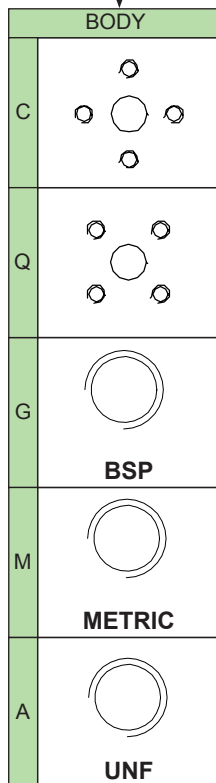

DISPLACEMENT	
41	XV-2P/ 4
43	XV-2P/ 6
45	XV-2P/ 9
47	XV-2P/ 11
49	XV-2P/14
51	XV-2P/17
53	XV-2P/19
55	XV-2P/22
57	XV-2P/26
59	XV-2P/30
61	XV-2P/34
63	XV-2P/40

DISPLACEMENT	
01	XV-0P/0.17
02	XV-0P/0.25
04	XV-0P/0.45
05	XV-0P/0.57
06	XV-0P/0.76
07	XV-0P/0.98
09	XV-0P/1.27
11	XV-0P/1.52
13	XV-0P/2.30
16	XV-1P/0.9
17	XV-1P/1.2
18	XV-1P/1.7
20	XV-1P/2.2
21	XV-1P/2.6
23	XV-1P/3.2
25	XV-1P/3.8
27	XV-1P/4.3
29	XV-1P/4.9
31	XV-1P/5.9
32	XV-1P/6.5
34	XV-1P/7.8
36	XV-1P/9.8

MULTIPLE PUMP XV-2

Ø 36,5 FLANGE

XV-2

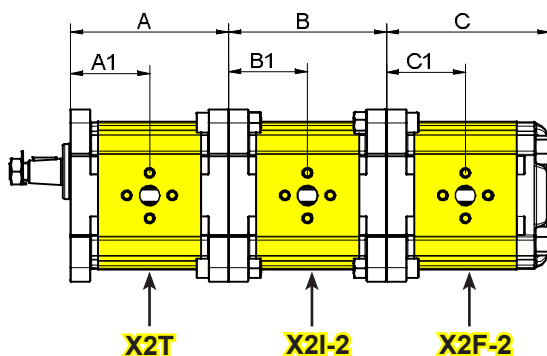
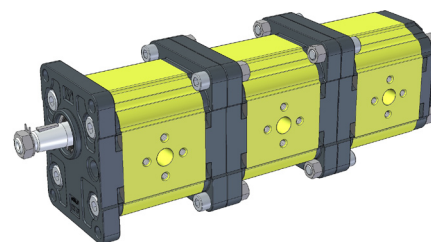
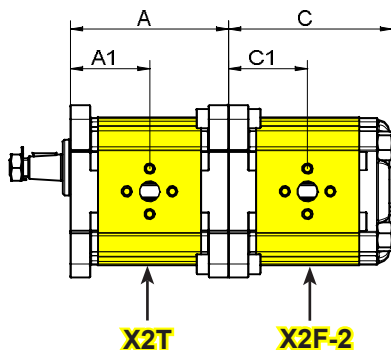
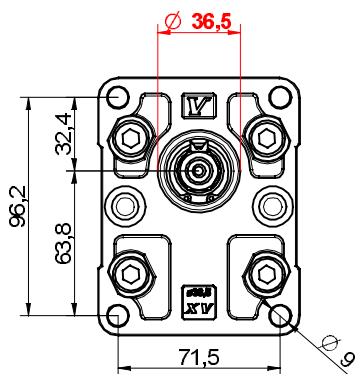

SEPARATED STAGES

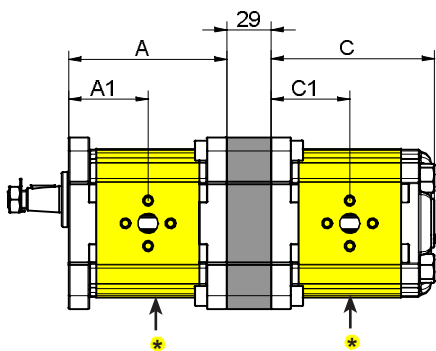

SINGLE INLET

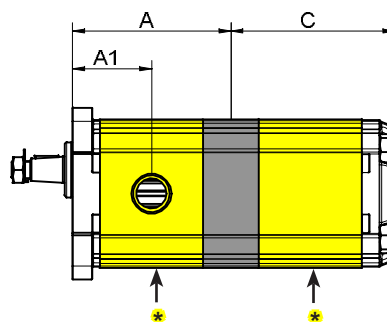

* = SPECIAL ELEMENT, please contact our customer service for details.

TYPE	Displacement cc/rev	A mm	A1 mm	B mm	B1 mm	C mm	C1 mm	P1 bar	P3 bar	Min speed rpm	Max speed rpm
XV-2 / 4	4,20	83,4	41,7	83,4	41,7	87,2	41,7	260	300	700	4000
XV-2 / 6	6,00	86,4	43,2	86,4	43,2	90,2	43,2	260	300	700	3500
XV-2 / 9	8,40	90,4	45,2	90,4	45,2	94,2	45,2	260	300	700	3500
XV-2 / 11	10,80	94,4	47,2	94,4	47,2	98,2	47,2	260	300	700	3500
XV-2 / 14	14,40	100,4	50,2	100,4	50,2	104,2	50,2	250	290	700	3500
XV-2 / 17	16,80	104,4	52,2	104,4	52,2	108,2	52,2	230	270	700	3500
XV-2 / 19	19,20	108,4	54,2	108,4	54,2	112,2	54,2	210	250	700	3000
XV-2 / 22	22,80	114,4	57,2	114,4	57,2	118,2	57,2	200	240	700	3000
XV-2 / 26	26,20	118,4	59,2	118,4	59,2	122,2	59,2	170	210	700	3000
XV-2 / 30	30,00	126,4	63,2	126,4	63,2	130,2	63,2	160	200	700	2500
XV-2 / 34	34,20	133,4	66,7	133,4	66,7	137,2	66,7	150	190	700	2500
XV-2 / 40	39,60	142,4	71,2	142,4	71,2	146,2	71,2	140	180	700	2000

MULTIPLE PUMP XV-2

Ø 36,5 FLANGE

XV-2

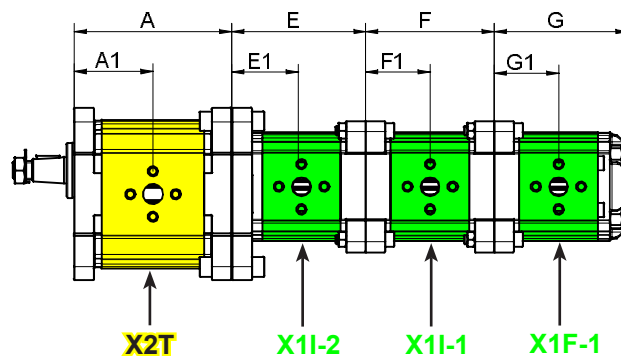
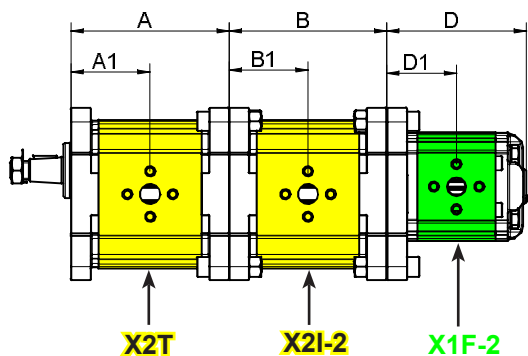
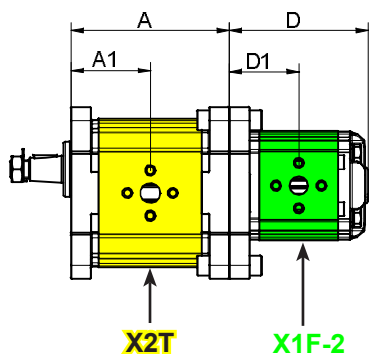
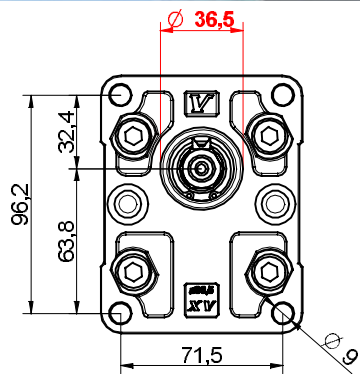

SEPARATED STAGES

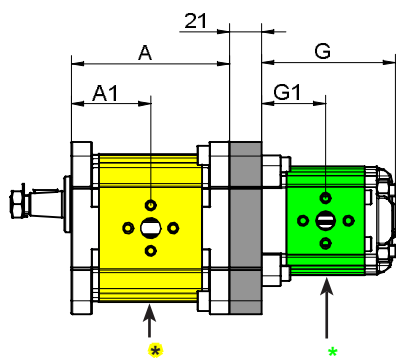

* = SPECIAL ELEMENT, please contact our customer service for details.

TYPE	Displacement cc/rev	A mm	A1 mm	B mm	B1 mm	C mm	C1 mm	P1 bar	P3 bar	Min speed rpm	Max speed rpm
XV-2 / 4	4,20	83,4	41,7	83,4	41,7	87,2	41,7	260	300	700	4000
XV-2 / 6	6,00	86,4	43,2	86,4	43,2	90,2	43,2	260	300	700	3500
XV-2 / 9	8,40	90,4	45,2	90,4	45,2	94,2	45,2	260	300	700	3500
XV-2 / 11	10,80	94,4	47,2	94,4	47,2	98,2	47,2	260	300	700	3500
XV-2 / 14	14,40	100,4	50,2	100,4	50,2	104,2	50,2	250	290	700	3500
XV-2 / 17	16,80	104,4	52,2	104,4	52,2	108,2	52,2	230	270	700	3500
XV-2 / 19	19,20	108,4	54,2	108,4	54,2	112,2	54,2	210	250	700	3000
XV-2 / 22	22,80	114,4	57,2	114,4	57,2	118,2	57,2	200	240	700	3000
XV-2 / 26	26,20	118,4	59,2	118,4	59,2	122,2	59,2	170	210	700	3000
XV-2 / 30	30,00	126,4	63,2	126,4	63,2	130,2	63,2	160	200	700	2500
XV-2 / 34	34,20	133,4	66,7	133,4	66,7	137,2	66,7	150	190	700	2500
XV-2 / 40	39,60	142,4	71,2	142,4	71,2	146,2	71,2	140	180	700	2000

MULTIPLE PUMP XV-2

Ø 36,5 FLANGE

XV-2

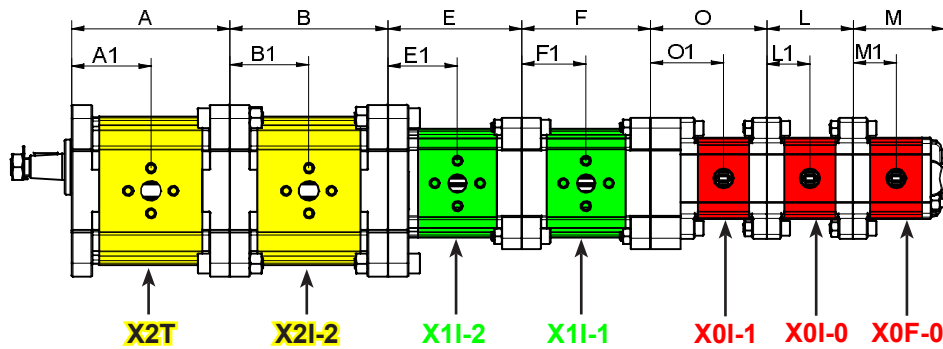
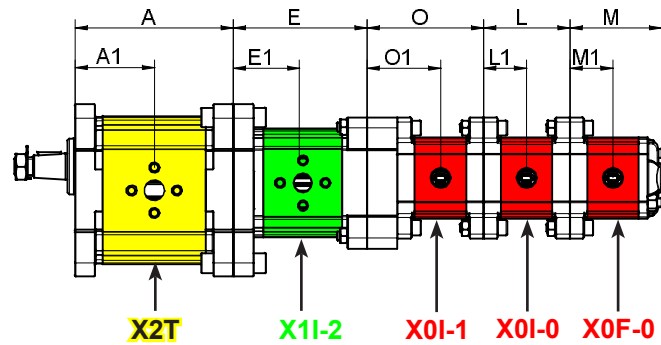
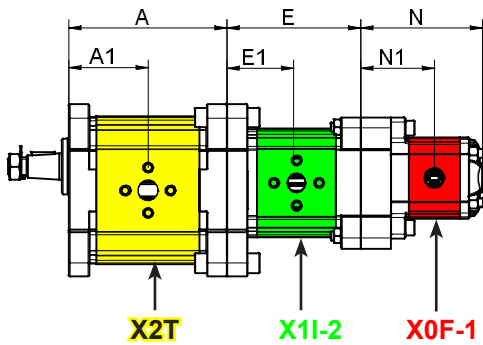
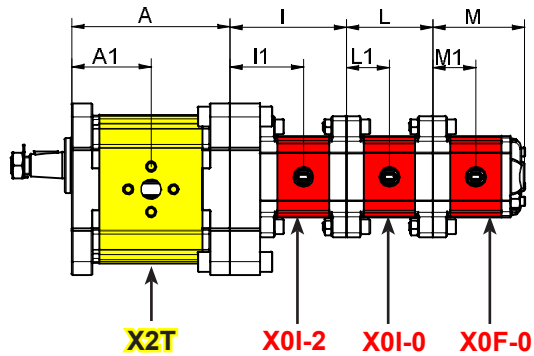
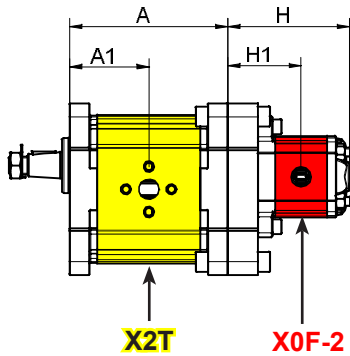

TYPE	Displacement cc/rev	D mm	D1 mm	E mm	E1 mm	F mm	F1 mm	G mm	G1 mm	P1 bar	P3 bar	Min speed rpm	Max speed rpm
XV-1 / 0,9	0,91	81,5	40,8	78	40,8	74,5	37,3	78	37,3	240	280	700	6000
XV-1 / 1,2	1,17	82,5	41,3	79	41,3	75,5	37,8	79	37,8	250	290	700	6000
XV-1 / 1,7	1,56	84	42	80,5	42	77	38,5	80,5	38,5	250	290	700	6000
XV-1 / 2,2	2,08	86	43	82,5	43	79	39,5	82,5	39,5	250	290	700	6000
XV-1 / 2,6	2,60	88	44	84,5	44	81	40,5	84,5	40,5	250	300	700	6000
XV-1 / 3,2	3,12	90	45	86	45	83	41,5	86	41,5	250	300	700	6000
XV-1 / 3,8	3,64	92	46	88,5	46	85	42,5	88,5	42,5	250	300	700	6000
XV-1 / 4,3	4,26	94	47	90,5	47	87	43,5	90,5	43,5	250	300	700	6000
XV-1 / 4,9	4,94	97	48,5	93,5	48,5	90	45	93,5	45	250	300	700	6000
XV-1 / 5,9	5,85	100,5	50,3	97	50,3	93,5	46,8	97	46,8	250	300	700	5000
XV-1 / 6,5	6,50	103	51,5	99,5	51,5	96	48	99,5	48	250	300	700	5000
XV-1 / 7,8	7,54	107	53,5	103,5	53,5	100	50	103,5	50	220	260	700	5000
XV-1 / 9,8	9,88	116	58	112,5	58	109	54,5	112,5	54,5	190	230	700	4000

TYPE	Displacem. cc/rev	H mm	H1 mm	I mm	I1 mm	L mm	L1 mm	M mm	M1 mm	N mm	N1 mm	O mm	O1 mm	P1 bar	P3 bar	Min speed rpm	Max speed rpm
XV-0 / 0,17	0,16	75,8	46,2	72,3	46,2	52,3	26,2	55,8	26,2	75,8	46,2	72,3	46,2	220	260	700	9000
XV-0 / 0,25	0,24	76,4	46,5	72,9	46,5	52,9	26,5	56,4	26,5	76,4	46,5	72,9	46,5	220	260	700	9000
XV-0 / 0,45	0,45	78	47,3	74,5	47,3	54,5	27,3	58	27,3	78	47,3	74,5	47,3	220	280	700	9000
XV-0 / 0,57	0,56	79	47,8	75,5	47,8	55,5	27,8	59	27,8	79	47,8	75,5	47,8	220	280	700	9000
XV-0 / 0,76	0,75	80,5	48,5	77	48,5	57	28,5	60,5	28,5	80,5	48,5	77	48,5	220	280	700	9000
XV-0 / 0,98	0,92	82	49,3	78,5	49,3	58,5	29,3	62	29,3	82	49,3	78,5	49,3	220	280	700	6000
XV-0 / 1,27	1,26	84,5	50,5	81	50,5	61	30,5	64,5	30,5	84,5	50,5	81	50,5	220	280	700	6000
XV-0 / 1,52	1,48	86,5	51,5	83	51,5	63	31,5	66,5	31,5	86,5	51,5	83	51,5	220	280	700	6000
XV-0 / 2,30	2,28	92,5	54,5	89	54,5	69	34,5	72,5	34,5	92,5	54,5	89	54,5	220	210	700	5000